

PACK RATS'



PACK RATS

CLUB CALL: W3CCX

MT. AIRY VHF RADIO CLUB, INC.

CHEESE BITS



MT. AIRY V.H.F. RADIO CLUB, INC., PHILADELPHIA, PENNSYLVANIA ARNS

(50.2, 145.2, 221.4, 432.03 & 1296.3 MHz)

AFFILIATED CLUB: AMERICAN RADIO RELAY LEAGUE

MEETINGS: THIRD THURSDAY OF EACH MONTH AT 8:00 P.M.

SOUTHAMPTON FREE LIBRARY, 947 E. STREET ROAD

SOUTHAMPTON, PENNSYLVANIA

VOLUME XVI

JUNE 1974

NUMBER 6

THE PREZ SEZ

Reports indicate that many people went scurrying to check the calendar after reading last month's Prez Sez column. That report on Ladies Night was premature, due to an erroneous press release date. However, it was factual and approximately 63 persons enjoyed the affair on May 4th at the Buck Hotel.

Congratulations to our V.P. WA3AXV, who was selected "Pack Rat of the Year" and was presented with a suitably engraved plaque at Ladies Night.

Plans are progressing for club participation in the June QSO Party (Hilltown, Pa., June 8th and 9th). The assistance of all members is required; minimum individual effort being a contact with W3CCX/3 on all the VHF bands on which you can operate.

The annual election of club officers and directors will be held at the general membership meeting on June 20th. The slate presented by the nominating committee is as follows:

Pres. Ron Whitsel, WA3AXV

V. Pres. - Tony Sousa, W3HMU

Lee Cohen, K3MXM

Harry Brown, WA3NGK

Rec. Secy - Carl Mattiace, WA3DJF

Cor. Secy - John Tate, K3KTY

Treas. - Doc Cutler, K3GAS

Directors - (Two to be elected)

Rich Pattison, K3ACR

Walt Bohlman, K3BPP

Bill Olson, W3HQT

Dave Mascaro, WA3JUF

Pete Shavney, WA3OVH

Additional nominations may be made from the floor until the voting begins. Be sure to come to this meeting and cast your ballot.

Why aren't we hearing more fixed stations via WR3ACD, our 220 MHz repeater? Transmitter adapter and conversion information has been provided both at Home Brew Night and in Cheese Bits.

Dick, W3FQD

PACK RATS' CHEESE BITS IS A PUBLICATION OF THE MT. AIRY V.H.F. RADIO CLUB, INC. PHILADELPHIA, PA. AND IS PUBLISHED MONTHLY.

10¢ PER COPY \$1.00 PER YEAR

WE OPERATE ON AN EXCHANGE BASIS WITH OTHER PUBLICATIONS AND ANYTHING THAT IS PRINTED IN CHEESE BITS MAY BE REPRINTED, UNLESS SO STATED, AS LONG AS THE PROPER CREDIT IS GIVEN.

* * * * *

DEADLINE FOR ARTICLES IS THE GENERAL MEMBERSHIP MEETING.

SWAP SHOP ITEMS - NO CHARGE

EDITOR:

W3CL, HARRY B. STEIN
2087 PARKDALE AVENUE
GLENSIDE, PA. 19038
215 - TU 7-5052

PUBLISHER AND SUBSCRIPTION MANAGER:

K3GAS, DOC CUTLER
7815 NEW SECOND STREET
ELKINS PARK, PA. 19117
215 - ME 5-1078

PRINTER:

K3ZKO, RON COHEN
6629 NORTH 5TH STREET
PHILADELPHIA, PA. 19126
215 - 224-3036

TRUSTEE OF CLUB CALL: W3CCX

W3SAO, FRANCIS BRICK
821 W. LINDLEY AVENUE
PHILADELPHIA, PA. 19141
215 - DA 4-7524

AWARDS CHAIRMAN:

W2EIF, JOSEPH KILGORE
#5 SUNNYBROOK COURT
STRATFORD, N.J. 08084
609 - 783-9478

TYPIST:

WA3TEM, MARSHA STEIN

OFFICERS: 1973-1974

PRESIDENT: W3FQD, DICK HUNTZINGER
VICE. PRES.: WA3AXV, RON WHITSEL
CORRES. SEC.: W3SAO, FRANCIS BRICK
REC. SEC.: WA3DJF, CARL MATTIACE
TREASURER: K3GAS, DOC CUTLER

DIRECTORS:

K3BPP, WALT BOHLMAN
K3KMN, GEORGE GAKOUMIS
W3YXF, JOE RUSHTON
WA3NGK, HARRY BROWN
K1SFF/3, TONY SOUZA

DIRECTORS' MEETINGS ARE HELD ON THE SECOND WEDNESDAY OF EACH MONTH AT DESIGNATED LOCATIONS.

MONDAY NIGHT NETS:	NET CONTROL
145.2 - 7:30 P.M.	W2EIF
50.2 - 8:30 P.M.	W3CL/W3GEW
221.4 - 9:00 P.M.	K3GAS
432.03 - 9:30 P.M.	K3IUV
1296.3 - 10:00 P.M.	K1SFF/3

FRIDAY NIGHT NET:	NET CONTROL
439.250 ATV NET -	K3ZKO/WA3AXV
19:00 HRS.	

A 5

Amateur Television Magazine

Be seen as well as heard



SUBSCRIPTIONS ONLY

\$2.50 A YEAR

P.O. Box 6512, Phila., Penna. 19138

CALENDAR OF COMING EVENTS

Syllabus by Lee, K3MXX

JUNE

8

Delaware Valley Chapter QCWA meeting will be held at the Buck Hotel in Feasterville, Pa. on June 8th. Cocktails at 6:00 p.m. Dinner at 7:00 p.m. The speaker will be M John Johnston, K3BNS, from the FCC in Washington, D.C. He is a Deputy to Mr. Prose Walker of the Amateur Division of the Federal Communications Commission.

8 - 9

VHF QSO PARTY - Hilltown, Pa.: This contest runs from Saturday afternoon till Sunday evening. Initial setting up is done on Friday afternoon and evening and helping hands are needed for the antennas, tents, and sundry equipment. If you want to join in the operation and be part of the fun, we'll be looking for you. The site is the Bux Mont Riding Field on Rt. 152 (Linkiln Pike) between Chalfont and Silverdale. More info. from the Chairman, Dave Mascaro, WA3JUF - Phone 674-0946.

10

The Semi-Annual meeting of the Philadelphia Area Repeater Association will be held on Monday June 10, 1974 at 8:00 P.M. The meeting will be held in the cafeteria of the General Electric Space Center located near the Valley Forge exit (#24) of the Pennsylvania Turnpike. Access to the cafeteria is via the main entrance.

12

Board of Directors Meeting - QTH WA3DJF, Carl Mattiace. 7317 Ryers Avenue, Philadelphia, Pa. If lost or need directions, phone RA 5-1928. Directors and interested parties invited.

20

General Club Meeting - ELECTION NIGHT Plus - NASA Film, "Lander on Mars" (28 MINS.) Southampton Free Library, Southampton, Pa. 8:00 P.M. This year many good men are standing for the offices of the club. To assure our continued forward progress, your opinion and votes are necessary. Make all plans to attend and vote, and express them through the candidate of your choice.
DOC'S Silent Auction! The Mario Raffle! Refreshments will be served.

21-22-23

ARRL Field Day: Full and complete details in QST. Many of the competing clubs will be operating the VHF modes and your contacts will be greatly appreciated.

17-23

National Amateur Radio Week

JULY

18

First outdoor meeting of the Season. AUCTION AT ZD'S The outdoor summer season meeting opens with the famous cellar clearing event in Zimmerman's Gulch. Yep - it is at the QTH of Dave Zimmerman, W3ZD and the way some of you Pack Rats have been accumulating "goodies" over the winter months, the auction tables should be overflowing and many bargains to be had. This is an open meeting and everyone is invited. Other hams, other clubs, other club members, electronic gadgeteers. Guessing Contest and ample refreshments... Mark your calendar now, for it will be an evening to remember.

19-20-21

ARRL National Convention - Waldorf Astoria, New York City.

23

BARC - Supper Meeting at the Casa Conti - Glenside, Pa.

20-21

UHF Space Net Contest Honoring Apollo 11

August 11

PACK RAT PICNIC

October 6

PACK RAT HAMARAMA

NEW PRODUCTS OF INTEREST TO HAMS

By Lynn, W3NSI

1. Hustler Master Gainer Antenna - 2M: New-Tronics Corp. has a new two meter 6 DB gain antenna rated at one KW FM. The G6-144-A fits masts or pipes up to 1 3/4" outside diameter, is ten foot high, with 4-21" solid aluminum radials. The unit is self supporting and is able to survive 100 MPH winds. Coax feed - 50 Ohms - to an 50239 socket. Price \$50.00.
15800 Commerce Park Drive, Brook Park, Ohio 44142
2. Hand Held Transceiver - 2M #1402SM: Wilson Electronics has produced a 6 channel FM T/R unit in a package approximately 2"x3"x9". The transmitter will put out 2 watts, and the receiver sensitivity is .3 microvolts. One very interesting feature of this radio is the snap on 12 watt amplifier unit which has built in charging facilities for the 1402SM, from a car cigar lighter socket. When this amplifier unit is used (#1410A) a separate microphone may be used in place of the built in unit in the T/R. Price \$239.00. Amp. \$99.00. P.O. Box 794 Henderson, Nev. 89015.
3. Roof Mount 220 Mc Antenna: Antenna Specialists Co. have an inexpensive 1/4 wave car roof antenna mount, which may prove of interest to those going mobile on 222.98/224.58. The HM 220 comes with 17 feet of RG 58 cable with a VHF connector. The antenna whip is 13" high, so no problem with garages etc. should be noticed. Rated for 100 watts. Price \$7.29.
12435 Euclid Avenue, Cleveland, Ohio 44106.

* * *

ARRL NITE 1974

Harry McConaghy, W3SW, the Atlantic Division Director represented ARRL headquarters this year and spoke at length about the recent league roundtable discussions with the FCC in Washington, D.C. Progress reported good.

Al Breirer, W3ZRQ, the E.Pa. SCM came down from Tamaqua escorted by Al Breiner, Jr. K3NYX. The SCM stressed appointments and presented W3CL with a stack of renewals.

George Gadbois, W3FEY, President of SERCOM of Lancaster, Pa. proposed a link-up on 450 MHz between the Lancaster and the Pack-Rat 220 MHz repeaters. The Lancaster area repeater is located in New Holland, Pa. (WR3ACE) operating on 223.34/224.94. The Pack-Rat repeater is located in Churchville, Pa. (WR3ACD) - operates on 222.98/224.58.

Carl Jacobson of the Clegg Division of ISC spoke about the improved FM 21 - 220 MHz Clegg Transceivers and presented a unit to the club to be raffled off at the upcoming Hamarama. Many thanks to the Clegg organization. FM-21 units are now available at Hamtronics.

The high light of the evening was the presentation to the club by Connie-Mac of the gavel for 1st Place in the 1974 January VHF Sweepstakes.

* * *

Basking Ridge, May 6th

Dear Folks:

Within a month or six weeks, the family here is moving to California and I will undoubtedly follow them there, after a few months visit with friends in Florida.

In so much as my personal address will be changing, thought it best to let you know in order that you may take me off your Cheese Bits list. Have really enjoyed receiving it here, with news of "old" friends, but assume you will not want to send it indefinitely.

At this writing I am feeling very good, for my age, Ha! Have such happy memories of Bill's association with your Club, and trust that some day our paths may cross again.

Remember me to all, with the very Best of Good Wishes,

Sincerely

Marie C. McCutcheon (XYL - Grandpa Bill,
K3HWZ)

VHF REPORT
By Jo, W2EIF

The bands continue to show little activity, 6 thru 1296. There have been a few small openings on 6 meters and aurora conditions have been noted several times on six also. No aurora activity was noted on 2 meters or above.

The big news was the appearance of WA6LET who was operating a high power final into a 150 foot dish on 144.080 CW and 144.105 SSB. From California the dish was pointed at the Moon. It was heard all over the East Coast and was worked by many stations. Those who were successful for the most part were using stacked beams on colinears mounted on a tilttable mount so as to point at the Moon at all times. Signals were so good that normal EME techniques were abandoned, and contacts were made in normal fashion. Some ops have several hours of solid signals recorded, many comparatively simple antenna like a 15 element beam mounted on a temporary post in the back yard. WA6LET is reported to be arranging to be trying it again in July, so you have plenty of time to prepare.

* * *

NEWS RELEASE

The Amateur Radio VHF Space Net is sponsoring a special commemorative Space Program, July 20, 21, 1974, which will honor the Apollo 11, (5th Anniversary) Moon Mission, "Man's First Landing and Walk on the Moon". The Federal Communications Commission has authorized the call letters "WM200N", to be used during this event. These call letters will be used on all Amateur Radio frequencies, (Worldwide).

Specially designed acknowledgement cards, reflecting this historic commemoration, will be exchanged with local and worldwide amateurs who work this call.

In conjunction with this event, the Honorable Brendan T. Byrne, Governor of the State of New Jersey, is issuing proclamation for Amateur Radio Week, July 15, 1974.

Additionally, a Nationwide VHF Contest will take place, where Amateur Radio Operators will contact each other, and those compiling the highest score will receive sterling trophies which will reflect the Apollo II, Mission. Open house at the VHF Space Net Center will prevail during this event, and the public is encouraged to join in "Man's Greatest Moment in Space."

Tony,
A.W. (Tony) Slapkowski, WB2MTU
Director

* * *

VISITORS AT THE MAY 16, 1974 MEETING

W3FEY, George Gadbois, Lancaster, Pa.	Carl Jacobson, Clegg Rep. Lancaster, Pa.
W3FBF, Paul D. Mercado (SEC) Broomall, Pa.	W3MFY, Press Funk, Trevoze, Pa.
W3ZRQ, Allen R. Breiner, SCM., Tamaqua, Pa.	K3PHY, Wil Burns, Willow Grove, Pa.
K3NYX, Allen R. Breiner, Tasbar, Tamaqua, Pa.	W3KD, George Hautenchild, Holland, Pa.
W2QLP, George H. Gierman, Trenton, N.J.	W3ZO, Boyd Cowan, Parksburg, Pa.
WA2WYE, Florence Power, Trenton, N.J.	W3SW, Connie-Mac, Bethesda, Md.
K3VYG, Gordon Vogt, Glenside, Pa.	K3PXX, Terry, Phila., Pa.
K3ATL, Frank Horman, W. Chester, Pa.	W3VIR, Bill, Holland, Pa.
	K3JFY, Bob, Levittown, Pa.
	W3WMB, Paul Aleoff, Lansdale, Pa.

* * *

OFFICIAL BULLETIN NR 480 FROM ARRL HEADQUARTERS NEWINGTON CT. MAY 9, 1974 TO ALL RADIO AMATEURS ET: The Senate has adopted and forwarded to the House the Goldwater Bill, Senate Joint Resolution 197, which would authorize National Amateur Radio Week June 17 to 23, 1974. The bill has been assigned to the Committee on the Judiciary of which the chairman is Peter Rodino, Jr. and ranking minority member is Edward Hutchinson, Suite 2137, House of Representatives, Washington D.C. 20515. AR

Our sympathy to Slim Tinsman, WA2QPC and his family on the passing of his beloved XYL Jeannette.

Dave, WA3JUF, Chairman of the June VHF QSO Party reports the following team captains:

- 6 Meters - WA3AXV
- 6 Meters (FM) - WA3NFV/W3CL
- 2 Meters - W3HQT (K1JDY/3)
- 2 Meters (FM) - WA3NFV
- 220 MHZ - W2EIF
- 432 MHZ - K3BPP
- 1296 MHZ - WA3JUF
- 2300 & UP - W3HMU (K1SFF/3)

Our friend, Herb Brown, W2HF, reports he will be active during the June VHF QSO Party and Field Day on 145.035 - Phone and on 432.2 - CW Location 22 miles East of Newburgh, N.Y. Be on the lookout for his signals.

Stan Smith, K3IPM, received his high scorer award for the January VHF SS at our May Meeting. Congrats Stan.

New 220 MHZ repeater operating out of Richboro, Pa. on 14/74.

Moonbounce info. presented by Joe, W2EIF, WA6LET operated on May 26th from 0200 - 0500 GMT. Horizon shot. 2000 - 2300 GMT - Overhead shot. Transmit freq. 144.080 first-30 seconds (CW) listening on 144.075 to 144.105 second-30 seconds.

Dave, K3BPK reports a picnic and get-together of the 6 meter FM (WR3ABE) gang. Aug. 4th at Ft. Washington State Park (Pack-Rat Location) Jack, W3ESQ has tickets for sale.

Bert, K3IUUV reports an Antenna Measuring Contest sponsored by the East Coast VHF Society on Sunday, August 4th. at Trenton State Teachers College.

Late Flash - The Pack Rats placed second in the recent 4th Annual Worldwide VHF Activity 1974 sponsored by the Itchycoo Park VHF A.R.S. Rich, K3ACR received the certificate.

Two of our members moved from the area and have resigned. Dave, W3TMY and Lou, WA3MIX. Good luck fellows.

Application for membership - WA3NDE, Hymen Ecksel (HY) 9801 Haldeman Ave. (Apt. B201) Phila., Pa. 19115

"Pro is the opposite of Con - As in Progress and Congress". W3FQD sez.

* * *

The following suggestion was received by Jo, W2EIF from Jack Sterner W2GQK. Reference May QST page 10 about Harmonic Hills support of the W2OVC million dollar suit for neighbor interference. "Has anyone questioned any insurance company for insurance against such suits? Seems to be that in as much as the Ham station is licensed and must conform to strict technical standards it would be a good low rate risk. Furthermore, I believe the shysters would think a second time before challenging an insurance company instead of an individual."

NOTE: What do club members and other readers think about this? Please let the editor know.

* * *



OFFICIAL BULLETIN NR 482 FROM ARRL HEADQUARTERS NEWINGTON CT MAY 23 1974 TO ALL RADIO AMATEURS BT: Attention DXers. Effective June 1, 1974, both Tibet and Zanzibar will be deleted from the ARRL Countries List. Contacts made June 1 and after with Tibet will be creditable toward the China, BY, listing, while contacts with Zanzibar will be creditable towards Tanzania, 5H3. The deletions will be reflected in the Honor Roll totals for the Sept. listing. As of June 1, this will make a maximum possible total of 355 with a possible total of 35 deletions. June submissions for the Honor Roll can, therefore, be made on the basis of a minimum undeleted total of 311. Effective July 1, endorsement stickers will be issued in increments of 5 above the 300 level. Further details page 95 June QST. AR

MT. AIRY V.H.F. RADIO CLUB, INC.



AD
MANAGER
K3MMW

ADS

<p>NR 7-0920</p> <p>GEORGE S. VAN DYKE, JR., P.E. CONSULTING ENGINEER</p> <p>W3HK</p> <p>4607 CONVENT LANE PHILA. PA. 19114.</p>	 <p>AMERICAN RADIO RELAY LEAGUE, Inc. HARRY A. McCONAGHY, W3SW/W3EPC DIRECTOR, ATLANTIC DIVISION, ARRL</p> <p>"Connie-Mac"</p>
 <p>PHIL THEIS Clegg Div. General Manager K3TDF</p> <p>ISC 3090 Hampland Road Lancaster, Pennsylvania 17601</p> <p>TEL: (717) 299-3671 TELEX: 94-8438 CABLE: INTERSIG</p>	<p>HARRY B STEIN ASSOCIATES COMMUNICATIONS CONSULTANTS</p> <p>HARRY B. STEIN 2087 FAIRDALE AVE. GLENSIDE PA. 19038</p>
<p><u>A request from your AD Manager</u></p> <p>PATRONIZE OUR ADVERTISERS Tell them you saw their ad in CHEESEBITS. Leave your QSL card with them. CHEESEBITS is one of the best read local radio club papers. Circulation - 300</p>	 <p>73 magazine for radio amateurs</p> <p>PETERBOROUGH, NEW HAMPSHIRE 03458</p>

ham radio the most interesting
amateur magazine:

1 Year \$7.00, 3 Years \$14.00

HAM RADIO MAGAZINE
Greenville, N. H. 03048

SWAP SHOP

FOR SALE OR TRADE: (Some good junk)

CDR TR44 Rotor

Hallicrafters R274 Receiver Similar to
SP 600 Standard broadcast band to 54 MHZ.

Ameco 621 VFO for 50,144 and 220 MHZ.

Cushcraft - Antenna for 220 MHZ (AM or FM)

2 ea. DX-220 Excellent condition

1 ea. DXK-240 1 1/2 yr. old

OS-8/U Oscilloscope - \$25.00.

Electra Bearcat (30 to 50 MHZ) Scanner
Model No. BCL.

SSB (Receiver) converter.

CV - 657A/URR for use with any receiver
having 455 KHZ I.F.

Gonset Communicator IV (220 MHZ)

Transceiver with Vanguard Pre Amp
and extra xtals.

CONTACT: Bill Murpby (K3ZSG)
206 Hancock Avenue.
Norristown, Pa. 19401

Telephone: Work - 592-3862 or 3863
Home - (after 6PM) 272-0558.

FOR SALE: Tektronix 513D Scope (\$100.00)

Ampro 16 MM sound projector & film, \$125.00

CONTACT: Doc Cutler, K3GAS
Tel. 635-1078

FOR SALE: G.E. Master Exec. 35 watt (or better)
Mobile, has all new control head, mike, speaker,
cables, etc. Unit is like new (\$255.00)

G.E. Portamobile 15 watt (or better) has nearly
new battery. Now on 150.510 MHZ - \$135.00

CONTACT: Ralph Hairsine, K3MPZ
1408 Wedgewood Road
Wilmington, Delaware
Tel. 302-994-6878.

FOR SALE: Saturn 6 Halo Mobile Antenna complete
with Mast and bumper mounting brackets. Brand ne
in original carton, \$10.00.

Ameco TX 62 - 6&2 meter xmitter. \$50.00.

Lafayette VFO - 50-54 MHZ/144-148MHZ. Excellent
condition, \$20.00.

Heathkit RF Signal Generator Model 102 (\$7.50).

6 meter lunchbox 6'er with whip antenna.
Excellent condition \$30.00.

2 meter lunchbox 2'er with 12v. pwr. supply for
mobile use. \$30.00.

Heathkit RF signal generator - Model SG 8 \$5.00.

Assorted boxes of parts for the asking.

Clegg 22'er AM & Gonset VFO. for 2,6, &220. Manua
Included. \$135.00.

Dumont Scope \$35.00.

Heathkit Scope (Manual Included) \$20.00; 40 ft.
Amerite Steel Tower, 11 element 2 mtr. beam
(cushcraft); 5 element 6 meter beam (cushcraft)

CDR Rotator = all for \$100.00.

CONTACT: Frank Simmons, WA3DLD, 1520 Crest Road.
Penn Wynne, Pa. 19151 Tel. MI 2-8834.

BARRACKS TRADING POST



Camping • Electronics • Canvas
 ROUTE 38 at RUDDEROW AVENUE
 MAPLE SHADE, NEW JERSEY 08052
 HARVEY PRIMOST 662-6114

665-0358
 MAIN OFFICE

Communications Sales and Service Co.

GEORGE A. RYAN
 General Manager

23 WILLOW ROAD
 MAPLE SHADE, N. J. 08052



Scott's Surplus Electronics

134 E. Park Av. Merchantville, N.J. 08109
 Division Of dab Associates Inc.

Pres: Scott Layman

609-685-2466



AMIL S. GUMULA
 PRESIDENT

A. G. RADIO PARTS CO.
 939 TOWNSHIP LINE RD.
 ELKINS PARK, PENNA. 19117
 TELEPHONE: 215-896-8100

RCA Authorized Distributor

HALLICRAFTERS
 FACTORY AUTHORIZED
 SERVICE

BUS. (215) MI 6-2511
 RES. (215) 277-5883

ELECTRONIC EXCHANGE

ALL TYPES OF HAM GEAR & ELECTRONIC EQUIPMENT
 BOUGHT, SOLD, TRADED & REPAIRED

new & used antennas

GORDON R. KITTEL
 K3AIG

311 E. WALNUT ST.
 (N. WALES RD.)
 NORTH WALES, PA. 19454

Dave Jones - WA3JLT
 Ben Schaefer - WA3ATP
 Phyllis Dorey - WA3OWG

Suburbs: (215) 449-2300
 Phila. (215) 529-8120

KASS ELECTRONICS DISTRIBUTORS



DISTRIBUTORS OF
 RADIO - TELEVISION PRODUCTS
 INDUSTRIAL ELECTRONIC PARTS & EQUIPMENT

2502 TOWNSHIP LINE ROAD
 (West of Lansdowne Avenue)
 DREXEL HILL, PA. 19028



215 898-2140

O. K. MARTIN
 MANAGER

LAFAYETTE RADIO ELECTRONICS
 of Chatsworth, Inc.

5155 QUONZ AVENUE WYNGO, PA. 18098

215-674-0300



LAFAYETTE RADIO ELECTRONICS

"Associate Store"
 531 Easton Road
 Horsham, Pa. 19044



PARTS - TEST EQUIP

Ed Clark



215 782-0261

J. E. GOMBERG
 MANAGER

LAFAYETTE RADIO ELECTRONICS
 of Oxford Valley, Inc.

174 OXFORD VALLEY HALL LANGHORNE, PA. 18042

K3MOM

JE 3-4660
 4661

LEE A. COHEN

CLAYTON L. HADY & SON
 INCORPORATED
 4527-31 HEDBE STREET
 PHILADELPHIA, PA. 19124

WIPING RAGS
 POLISHING CLOTHS
 COTTON & WOOLEN WASTE



ELECTRONIC CENTER
 SCHLUMBERGER PRODUCTS CORP.
 OVER 300 ELECTRONIC KITS

TED HALDIS
 MANAGER
 K3EPK

6318 ROOSEVELT BLVD.
 PHILA., PA. 19148

TELEPHONE
 215 CU 8-0180

W3CJU

DONALD KRAUT HAMPTON

Jeweler - Watchmaker

ROGER W. KRAUT
 31 W. State Street
 Doylestown, Penna.

Phone
 Bus. 348-4884
 Res. 348-8969

LOcust 7-7130

K3KTY

TRANSPORT EQUIPMENT COMPANY

"Everything for the Truck"

JOHN A. TATE
 PRESIDENT

2215 - 2217 RACE STREET
 PHILADELPHIA, PA. 19103

PATRONIZE OUR ADVERTISERS

Tell them you saw their Ad in
 CHEESE - BITS



W3KKN

ERNEST KENAS

TOOL DESIGN
 MANUFACTURING ENGINEERING DEPARTMENT

THE BUDD COMPANY
 AUTOMOTIVE DIVISION

PHILADELPHIA, PA.

609.429.0087

BRADDOCK ASSOCIATES
 MANUFACTURERS' REPRESENTATIVE

EDWARD BRADDOCK
 MEMBER: E.R.A. & I.E.E. HADDONFIELD, N. J. 08033
 W2BAY

POST OFFICE BOX 308
 HADDONFIELD, N. J. 08033



COMPLETE HOME WINE MAKING SUPPLIES



WINE CELLAR SUPPLY HOUSE

BETHLEHEM & BUTLER PIKES
 AMBLER, PA. 19002

JOHN COSTA

(215) 843-3585

(609) 663-8236

SWEETMAN CALIBRATION SERVICES
 ELECTRONIC TEST EQUIPMENT CALIBRATION

GERHARD J. SWEETMAN

2672 GLADWYN ROAD
 PENNSAUKEN, N. J. 08109

-7A-

15 April 74

Howdy Doc,

Enclosed please find my dues for this year. Was very sorry to hear of Mario's passing. His talent will be sorely missed by the club. Finally got on the air from the QTH out here and have a few small antennas up. It's really amazing what a few pounds of fresh filleted lingcod will do when asking for a favor from the park manager. Been checking into the N. Cal VHF SSB net on 145.05, so perhaps it's not all FM out here. Will be at the West Coast VHF Conference on May 4-5, so if anything interesting occurs, I'll shoot off the hot skinny to the Club post haste.

As for Elliott's request for tech manuals, I have the following in my possession: HX-30 SSB xmtr (6 meter), Clegg Interceptor "B2 and 99er, SB-610, 620, 630, Drake WV-4 wattmeter, Johnson 6n2 T-Bolt, Omega T extended range antenna noise bridge, Amaco 621 VFO, Tecraft Critrion series converters, Ameco "CN" series converters.

I also have access to military tech manuals for obsolete gear commonly found in surplus marts which we still use here at Moffett Field. These will have to be Xeroxed, because the papyrus parchment they are made of will crack if I try to mail them. Have to close now, but will keep you posted on the West Coast scene. Give my best to the gang.

73, ETC Bill Fulling, WA2UUV/6
1358 Oakland Rd. #74
San Jose, California 95112

* * *

A REPORT FROM E.W. HALDEMAN, W3PST RADIO OFFICER - OFFICE OF EMERGENCY PREPAREDNESS, PHILA.

Sometime during the first week in May of each year, the Philadelphia County Medical Society, in conjunction with many supporting agencies, including this office (formerly Philadelphia Civil Defence Council), holds some kind of a Disaster Exercise. This year the scenario was written around a simulated wide-body aircraft crash on the edge of the Philadelphia International Airport (PIA), with "casualties" numbering over 250. These were sent to nearby hospitals by ambulances, fire rescue and police vehicles. The hams were alerted and sent to the various hospitals to do their "thing." They were to report the arrival of "casualties" and the condition of the emergency wards, that is, full, or whatever. Also, to report later that the "casualties" were not getting into trouble waiting around for their return ride. It all worked out very well. As I said the use of Phil-Mont's repeater was a good choice, because it really covers Philadelphia like a net, literally. The ham part in the exercise was flawless and everyone learned a lot, including us, which was the purpose of the thing in the first place. There were no "canned" or "test" messages, our's being real, bonafide information. Phil-Mont's "Yellow Peril" participated as a command center at PIA.

WB2LGY, W3's HFY, JGB, GLF, QQH, PST, K3's KNH, UWO, TGM, WA3JSR. Participants:

73, Woody

* * *

THE AMERICAN RADIO RELAY LEAGUE, INC.
Newington, Donn., U.S.A. 06111

APRIL 18, 1974

Mr. Edgar Reihl, WA9ULU
Northwestern University ARC, W9BGX
2145 Sheridan Road
Evanston, IL. 60201

Dear OM:

Your letter to Jo, W2EIF, was quoted in the Pack Rats Cheese Bits for April. In Part it said,

". . .I could hardly believe it when ARRL pressured FCC to give Technicians 145-148 but not the low end of 2 or 6. . ."

You shouldn't believe it at all because both parts of the sentences are completely untrue.

The League has been trying to get FCC to open up the entire 144-148 MHz band for Technicians since 1969, when RM-1535 was filed with the Commission. The same document also asks for dual Novice and Technician license holding to be restored, and for a part of the ten-meter band to be opened to Technicians. On the other hand, the extension of the Technician band at 2 meters from 145-147 to 145-148 came on the Commission's own motion as part of the Repeater Docket, 18803. Don't misunderstand: the League is in favor, because it is a

partial fulfillment of our long-standing request, but we didn't " . . . pressure the FCC. . ." at that point in time for only these frequencies.

And as concerns six meters, we lost that one, but not for lack of trying. Two separate attempts were made to allow Technicians and Generals to continue operating on the low end of the band. Twice our petitions in this respect were denied by FCC; since then, a private petition along the same lines also has been denied.

We are also urging amateurs to support HR3516, the Teague Bill to require that TV receivers be shielded and equipped with filters by the manufacturers, so as to avoid interference from nearby amateur stations. If this bill passes, it should eventually free up our six meter band (though of course its effects would take years to become universal).

The League has its headquarters in Connecticut, but its plans and policies come from all over -- direct from members, through club bulletins, through the elected directors which serve sixteen geographical divisions and through four Advisory Committees (VHF Repeaters, Contests, DX, Emergency Communications) which usually have one member from Canada and one from each U.S. call area. Moreover, the League's professional staff also comes from all over the U.S.; the top man, General Manager Huntoon, W1RW, was originally W9TJY in Glen Ellyn, Illinois! It isn't clear from your letter to Jo in just what respect you feel the League is East-oriented, so I'd appreciate more information.

73,

Sincerely yours,

Perry F. Williams, W1UED

Assistant Secretary for Membership Services

PFW:mmt

cc: Mr. Joseph R. Kilgore, W2EIF

* * *

CHEAP AND EASY 220 REPEATER RIG, PART 2, by BERT, K3IUV: Last month I described a method for modifying the receiver portion of a Link model 2975, 450 MHz transceiver for use with the Packrat 220 repeater. This month I will describe the modifications required to put the transmitter section on 220.

I used the same basic approach; namely, select a starting oscillator frequency which minimizes the amount of retuning required. Figure 1 shows the transmitter block diagram. Again two sets of frequencies are shown. The upper ones are the unmodified (450) values, while the lower ones are the modified (220) values. Note that the original tripler (V7, a 5894) is changed to a doubler and serves as the output stage. More about that in a moment.

The output tanks of V3, V4, and V5 have sufficient range to adjust to the new frequencies. The output of V6 must be padded to resonance. I used a 3-13 pf ceramic trimmer from the plate of V6 to ground, rather than rewind the coil. You may find it necessary to squeeze the turns on the grid tank of V7 to optimize grid current. V7 was originally connected as a push-pull tripler. The balanced configuration of such a circuit inherently suppresses even harmonics so it cannot be used as a doubler. However, if we connect the 5894 as a push-pull circuit it will provide even harmonic output. To do this we connect the input grids in push-pull, and the output plates in parallel driving a single ended tank circuit. This part of the modification presented the greatest difficulty. Since the output capacity of the 5894 is relatively high, in parallel we present the tank with double the individual capacity, whereas in the push-pull tank it is halved.

I tried a number of tank circuits (strap, heavy bus, etc.) but could not get above 180 MHz with any of them. The trick that finally worked was to use series tuning of the tank circuit as that the output capacity is in series with the tank capacitor. The modified tank circuit is shown in Figure 2. One further comment regarding stability. Within the constraints of the existing chassis layout there was evidence of instability as long as I used a Z220 rf choke in the B ϕ feed to V7. Using a Z144, the instability could not be detected. I do not claim the output stage is an optimum design. I only claim it works and provides about 1 watt output (with 300 volts B ϕ).

I used a piece of brass bar stock to make the special plate connector as shown in Figure 3.

CHEAP AND EASY 220 REPEATER RIG, PART 2 CONTINUED FROM PAGE 9:

Don't try copper as you will break too many taps.

One other peculiarity of the model 2975 must be noted. These units were originally built for 6 volt operation and modified in the field for 12 volts by rewiring the filaments in a series parallel arrangement. V7, V8, V6, V115, and V116 are wired in parallel, and then in series with all other filaments paralleled. If you decide to remove V8 you must account for its filament current. For home use, the simplest approach is to wire all filaments in parallel and use a 6 V supply. This can be done by moving two wires. For mobile 12 V use you must redistribute the series-parallel filaments. If interested, I can provide the details.

In conclusion then we have provided a 220 repeater transceiver at virtually no cost and end up with a spare 5894! The same general technique can be applied to either 450 MHz gear if you are so inclined. I'd be interested in hearing from anyone that tries a similar modification.

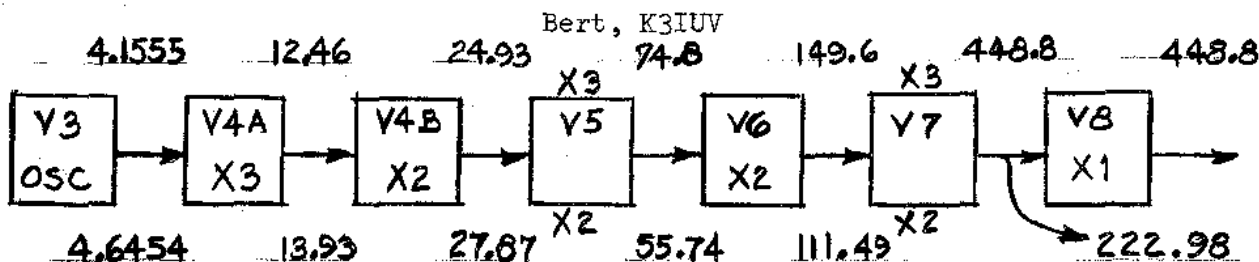

FIG. 1 - TRANSMITTER BLOCK DIAGRAM

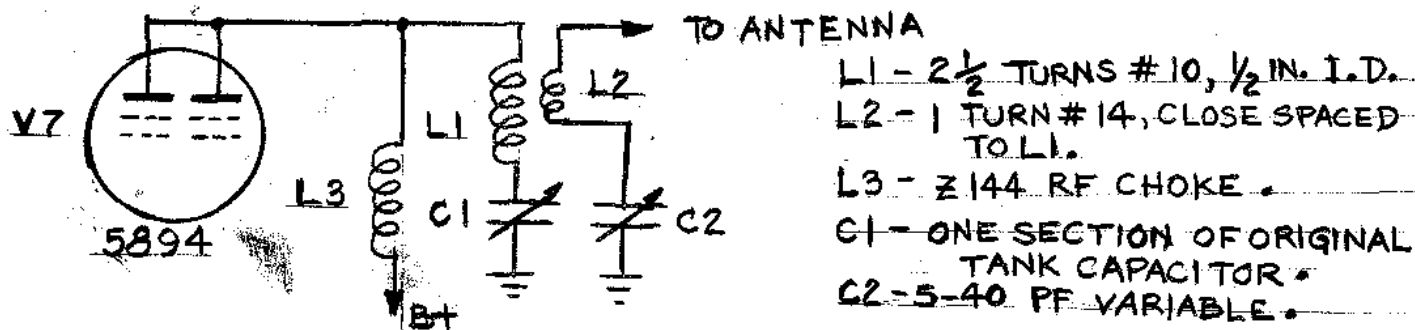

FIG. 2 - OUTPUT STAGE TANK CIRCUIT

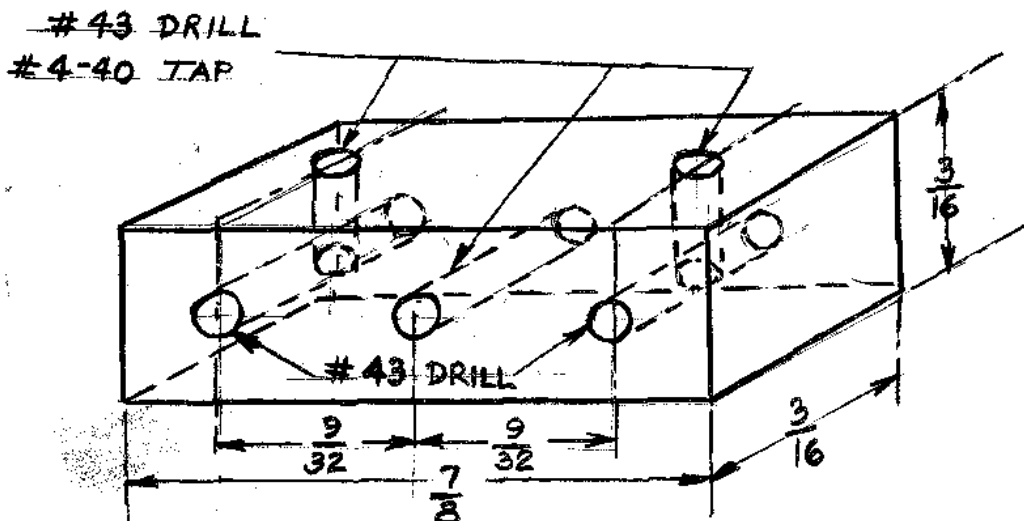

FIG. 3 - PLATE CONNECTOR

SWAP SHOP
CONTINUED FROM PAGE 7

FOR SALE: SB 102 - Wired by engineer - Mint condition, includes 110V. A.C. Supply - Mobile supply & mobile mounting bracket. Mike & speaker, \$500.00
CONTACT: Ken Simons, W3UB
Tel. 674-4800 or
WI 7-5905

FOR SALE: 220 MHZ transmitter (25 watts) xtal. at low end and 221.4 MHZ. Mike included R48 receiver with preamp. \$100.00.
Clegg Zues - 220 Watts, Brand new \$295.00
6 & 2 Thunderbolt - 1000 watts, \$495.00
Swan 250 - 6 meter transceiver (SSB-CW/AM) \$295.00.
Supply for above & matching speaker \$75.00.
Gonset 2 mtr. sidewinder transceiver SSB-CW/AM with mike and power supply. \$250.00.
Drake CC-1 Console with 2 & 6 meter converters and calibrator - 14 MHZ I.F. \$175.00.
Amece Nuvistor converters for 2, 6, & 220 with A.C. Supply - 28-30 MHZ I.F. \$100.00.
Will sell separately \$30.00 each converter, \$10.00 for power supply.
15 Element 2 meter Hi-gain antenna.
28 ft. long John) \$20.00
8x8 220 MHZ J-beams (\$20.00)
Cushcraft 16 element 220 Mhz colinear-modified per Pack Rat info. \$20.00
CONTACT: Dave Funk, WA3CAG
Tel. Day -EL 7-1400
Nite - 357-8968

WANTED: Swan TV-2 in good working condition - State price.
CONTACT: Ray Buckshaw, WA2QDE/5
Box T-1042
Tinker AFB, Okla. 73145

WANTED: 2 Meter FM Mobile Transceiver
CONTACT: Charlie Giannetta
5485 Colony Drive
Bethlehem, Pa. 18017
Tel. (office) 264-2241

WANTED: 29 inch aluminum dish - State Price.
CONTACT: Bill Pawson, W3VIR
215-EL 7-0234

* * *

FROM NORTHEAST VHF NEWS:

Thoughts on Calling Frequencies from K1PXE: "For some time now I have been racking my brains for ideas to get the techs and higher class licensees together on two meters. Following on K1OJQ's idea of using 220.100 MHz as a calling frequency, and our net practice of checking in stations on 144.120 and 145.120 MHz, I am suggesting that techs use 145.110 as a calling frequency (particularly for SSB) and when calling a station on the low end, call exactly 1 MHz higher. In turn, stations on the low end would only have to flip one switch on the receiver or converter, possibly peak up the preselector, and rock the dial back and forth to get the tech stations. Hopefully this would gather the SSB activity which is now spread between 145.00 and 145.250 MHz, and provide a procedure for techs and higher class licensees to QSO with minimal change in current operating practice. So far the dozen or so with whom I have spoken about this idea are enthusiastic about it."

MT. AIRY VHF RADIO CLUB INC.

A U C T I O N

€

PACKRAT AUCTION
AMATEUR RADIO EQUIPMENT



PACK RATS

CLUB CALL: W3CCX

JULY 18, 1974

8:00 PM

QTH: W3ZD DAVE ZIMMERMAN
520 CENTENNIAL ROAD
WARMINSTER PA. 18974
PHONE: 675 4539

RADIO EQUIPMENT

CONSIGNMENTS INVITED

REFRESHMENTS

RAIN OR SHINE

BRING A FRIEND AND A CHAIR

Q S O PARTY MAP

Take Penna. Rt. #309 to U.S. #202, turn RIGHT (North) on U.S. #202 to Chalfont (about 3 miles) and Penna. Rt. #152 North. Turn Left on Rt. #152, travel North about 5 miles to HILLTOWN. Site is at the Hilltown Civic Assn. Field, about 1 block North of the center of town on Rt. #152.

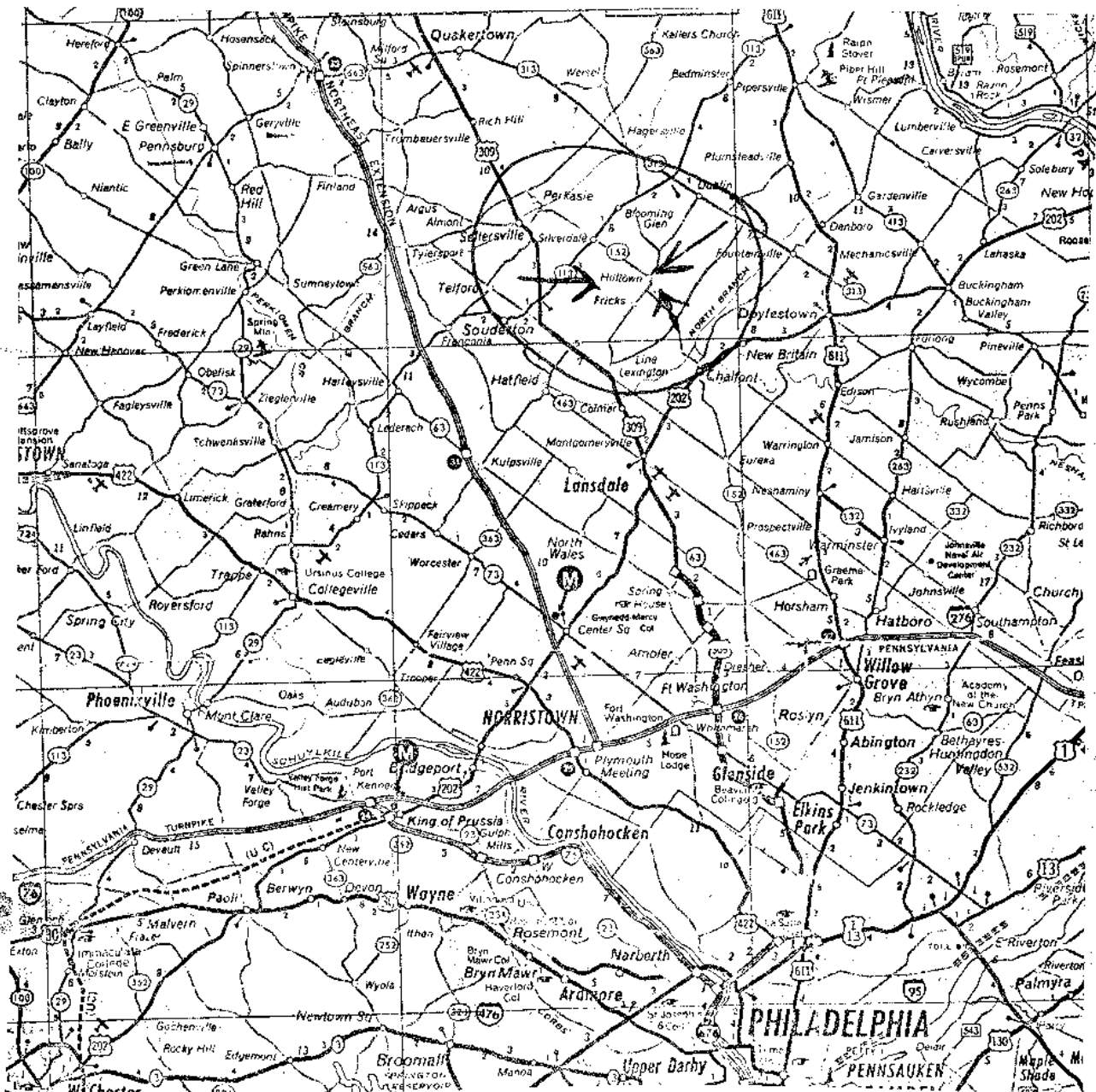

Cheese Bits
2087 Parkdale Ave.
Glenside, Pa. 19038

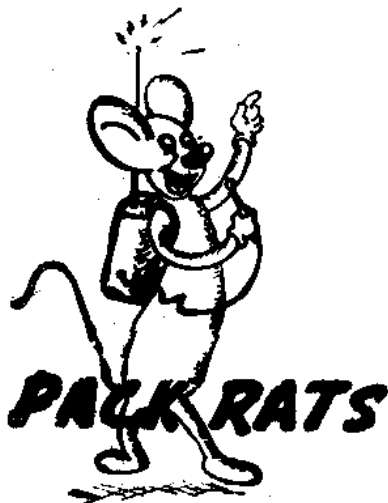

MT. AIRY VHF RADIO CLUB, INC.

MEETING NOTICE

FIRST CLASS

AMATEUR RADIO EQUIPMENT

"Ham" Buerger, Inc.

66 N YORK ROAD, WILLOW GROVE, PENN. 19000
(215) OL 9-5900

STORE HOURS

Mon. 9:30 to 5:30
Tue. 9:30 to 5:30
Wed. 9:30 to 9:00
Thur 9:30 to 5:30
Fri. 9:30 to 5:30
Sat. 9:30 to 5:30