

PACK RATS'



PACK RATS

CLUB CALL: W3CCX

MT. AIRY VHF RADIO CLUB, INC.

CHEESE BITS



MT. AIRY VHF RADIO CLUB, INC., PHILADELPHIA, PENNSYLVANIA ARNS
50.125, 144.150, 220.125, 432.110, 1296.110 Mhz, W3CCX - Repeater 222.98/224.58 Mhz
Affiliated Club: AMERICAN RADIO RELAY LEAGUE
Meetings: Third Thursday of each month at 8:00 P.M.,
Southampton Free Library, 947 E. Street Road
Southampton, Pennsylvania 19866

VOLUME XXVI

MARCH, 1986

NUMBER 3

THE PREZ SEZ

The scores have been tabulated at Zimmermans' Glen and the results show the Pack to be around 1.8 million points. Congratulations to all the members that produced the 59 logs for their effort.

The February meeting was our annual "HOMEBREW NITE" which was well attended and once again proved that home electronic construction is not dead among the Pack-Rats. Congratulations to all the winners (there were no losers) - all of the exhibitors did outstanding jobs. This year brought about some new categories. For details see page 6 and page 10 for photos.

Doc reminds us that Ladies Nite will be May 31st 1986 at the Warrington Motor Lodge in Warrington, Pa. This banquet, like our meetings, is opened to all. So come out as we pay tribute to those long suffering YLs and XYLs.

The ARRL is again treating us to a session of VHF/UHF Spring Sprints. The Sprints are excellent for keeping those contest skills sharp. All Sprints run from 7 PM to 11 PM local time and are single operator only. You simply exchange grid square locators. Date are as follows:

144 Mhz - April 14th; 220 Mhz - April 22nd; 432 Mhz - April 30th;
1296 Mhz - May 8th; and 50 Mhz - May 17th.

Good luck es 73,

Mike, WB2RVX

Pack Rats XHEESE BITS is a publication of THE MT. AIRY VHF RADIO CLUB, INC. Philadelphia, Pa. and is published monthly.

SUBSCRIPTION RATE - \$3.00 PER YEAR

We operate on an exchange basis with other publications. Anything that is printed in CHEESE BITS may be reprinted, unless otherwise stated, provided that proper credit is given.

SWAP SHOP ITEMS - NO CHARGE

DEADLINE FOR ARTICLES IS THE GENERAL MEMBERSHIP MEETING: THE THIRD THURSDAY OF THE MONTH.

EDITOR:

W3CL, HARRY B. STEIN
2087 Parkdale Avenue
Glenside, Pa. 19038
215-887-5052

PUBLISHER/SUBSCRIPTION MANAGER:

K3GAS, DOC CUTLER
7815 New Second Street
Elkins Park, Pa. 19117
215-635-1078

PRINTER:

WB2VLA, DAVID POWER
609-882-1040

TYPIST:

WA3TEM, MARSHA LISSAUER

TRUSTEE OF THE CLUB CALL - W3CCX:

WA3AXV, RONALD WHITSEL
215-355-5730

AWARDS CHAIRMAN:

W2EIF, JOSEPH KILGORE
609-783-9478

CLUB HISTORIAN:

W3CL, HARRY B. STEIN

MONDAY NIGHT NETS

7:30 PM - 50.125 MHZ
3:00 PM - 144.150 MHZ
3:30 PM - 222.98/224.58 MHZ
3:45 PM - 220.125 MHZ
4:00 PM - 432.110 MHZ
4:30 PM - 1296.1 MHZ

NET CONTROL

W3CL
W2EIF
K3GAS
KS2T
K3IUV/K1PXE
- - -

PACK RAT REPEATER 222.98/224.58 MHZ/ W3CCX
LOCATED IN CHURCHVILLE, PA.

OFFICERS: 1985-1986

PRESIDENT: WB2RVX, MIKE GULLO
VICE-PRES: WA2OMY, GARY HITCHNER
COR. SECY : W3CXU, JOHN ALLEN
REC. SECY : W3NST, LYN ROWLAND
TREASURER: K3GAS, DOC CUTLER
DIRECTORS: WB2VLA, DAVE POWER (EX-OF)
N3CX, DAVE HACKFORD (2 Yrs)
WA3JUF, DAVE MASCARO (2 Yrs)
WA3AAJ, JIM WARD (1 Yr)
WB3IND, GEORGE McMAHON (1 Yr)

THE AMERICAN RADIO RELAY LEAGUE

QST

HUGH A. TURNBULL, W3ABC
Director, Atlantic Division

6903 RHODE ISLAND AVE.
COLLEGE PARK, MD. 20740

(301) 927-1797

1-302-478-2757

AMATEUR
and
ADVANCED
COMMUNICATIONS

G. B. WALLS

3208 CONCORD PIKE (RT. 202)
WILMINGTON, DEL. 19803

Pennsylvania Institute
of Technology

PAUL D. MERCADO
Chairperson, Drafting Design Department

(215) 565-7900

Rose Valley-Notre Dame Campus
800 Manchester Ave., Media, Pa. 19063-4098

FOR SERVICE CALL:
(215) 672-3950
(215) 522-1408

MICHAEL McMACKIN

REGISTERED PLUMBING & HEATING
BATHROOM INSTALLATIONS • ELECTRIC DRAIN CLEANING

1307 HUNTSMAN DR.
LAFAYETTE, PA 15832

2405 PARKSIDE AVE
HATBORO, PA 19040

CALENDAR OF COMING EVENTS
Syllabus by Lee, K3MXM

MARCH

- 1-2 ARRL International DX Contest - Phone: See Dec. QST Page 93
- 8 Orlando, Florida Hamfest - if you are in the area - well worth attending.
- 9 Tired of all the Winter gloom - visit the potent of Spring - The Philadelphia Flower Show, Civic Center. A real beautiful way to spend a couple of hours. All week.
- 11 You think we had snow last month - well, today marks the anniversary of the Blizzard of '88. Ask any of the ole timers.
- 13 Board of Directors Meeting - QTH: WB2OMY, Gary Hitchner, 39 W. Mt. Kirk Avenue, Norristown, Pa. (If lost: 539-6409) Directors and interested members always welcomed.
- 14 Something new and different - An evening Hamfest. The Split Rock Amateur ARC will hold one at the VFW Post - Tabor Rd. (Route 53) and Route 202 in Morris Plains, N.J. Doors open 7 PM. This area is about an hour plus Northeast of Phila. For further information - SARA - P.O. Box 3, Whippany, N.J. 07981
- 15 (Saturday) PACS (Philadelphia Area Computer Society) Computer Festival - LaSalle College, 11 AM to 4 PM
- 17 Everybody is IRISH today - be wezring of the green. St. Patrick's Day
- 20 General Club Meeting: Topic: Robert Schafer, WA3YYK - Pres. Uniform Tube (UT)* The Mario Raffle, Frankie's Silent Auction. Free refreshments. An open meeting and all amateurs always welcome. WA3YYK will talk on FILTERS in CABLES
* Literature will be available.
- 22 Charlotte, N.C. hamfest
- 22 (Saturday) SPARC - Shore Points ARC Springfest '86 4-H Fairgrounds - Egg Harbor City, N.J. Talk-in 146.385/.985. Further Information: SPARC, P.O. Box 142, Absecon, N.J. 08201
- 23 Delaware Valley Radio Association, W2ZQ - Hamcomp '86 N.J. National Guard Armory Eggerts Crossing Road (Lawrence Township) Trenton, N.J. Inside Space Available. DVRA Hamcomp '96 P.O. Box 441B RD #1, Stockton, N.J. 08559. Talk-in 146.07/67. A very good local Hamfest and well worth attending.
- 23 PALM SUNDAY
- 26 SJRA Invitation to attend their general meeting at the Pennsauken High School on Remington Avenue off Route 73 at 7:30 P.M. The program will feature Hugh A. Turnbull, W3ABC, ARRL Atlantic Division Director, come out and get the latest scoop on doings at the ARRL.
- 26 VEC testing sponsored by the Warminster ARC. Will be given at the Willowdale Elementary School, Warminster, Pa. Testing starts at 6:30 P.M. - Just walk in! For additional info. Contact N3AOG, Dick Comly on 443-9965.
- 28 Good Friday
- 29-30 CQ World Wide Prefix Contest - Phone
- 30 EASTER SUNDAY

NEW PRODUCTS OF INTEREST TO HAMS

By Lyn, W3NSI

1. GAASFET PREAMPS: Hamtronics (Hilton, N.Y.) has introduced a line of GassFET preamps, both kit and wired, for 144,220, and 432 Mhz. The LNW series units are on open PC boards for mounting in your own case or inside the transceiver. Price for these very small preamps is Kit \$19 and Wired \$38. The LNS series in line preamps feature automatic switching for transmitter power up to 25 watts. LNS could be installed in the line between the exciter and PA or at the antenna if 25 watts or less is used. Tower mounting hardware is included. Price Kit \$68 Wired \$98 (65-D Moul Road 14468)
2. SMALL ALUMINUM TOWERS: Alinco Electronics has four size of towers for use with oscar antennas or small HF beams for roof mounting. Sizes range from 3 1/2 to 6 1/2 feet high and all have a rotor mounting shelf. Other features are all bolted construction, four legs for ease of mounting on peak roofs, and provision for a top mounted thrust bearing. Prices range from \$67 to \$107. P.O. Box 70007 Reno NV 89570.
3. ICOM AUTOMATIC ANTENNA SYSTEM AH-2: The AH-2 was designed for use with the IC 735 HF Transceiver. The system comes with a 107" stainless steel whip and mount, a control box for use at the T/R, cables for interconnections, and tuner unit which is mounted in a plastic box that can be placed in the car trunk or on an apartment balcony. The unit may be purchased without the whip and mount for those who wish to feed a random wire at a base location or have a whip mounted on the car. The unit will work all bands 10-80 and with an extension on the whip or with a wire 38' long will also operate on 160 meters. Average tuning time is 2-4 seconds and can tune from 10 to 80 in six seconds. The case measures about 9" by 14" and there is a lot of "stuff" inside there. It almost looks like another T/R. List Price \$550.

* * *

ANOTHER BELATED "CRYING TOWEL"

Enjoyed reading Cheese Bits and the Crying Towel synopsis. Didn't have too much go wrong here. The main thing to cry about up here in the sticks is lack of activity. Even the Boston boys were few and far between. Did manage to work WA3AXV and N2SB on 4 bands each and WB3JYO and WA2OMY on 2M. Heard Ernie a couple of times on 2 but no go. Finally got the 6M stuff going and threw up a 4 element beam about 30 feet up the tower fixed in the Southwest. Couldn't find the Variac for the KWH.V. supply so ran the barefoot exciter. Did manage to work a few 9's and 0's during the E skip opening Sunday afternoon. Water got into my 432 feedline sometime early Sunday morning and signals got weaker and weaker for the rest of the contest. At the end - Nothing at all, Hi! 1296 activity was very poor, just worked a couple FN42 stations, however, I finally DID work my own grid! K1RQG is now on. He's near Bangor about 30 miles east of here. You have probably heard by now I am writing a column in QEX. It will be a monthly thing focusing on VHF and up technology. Starts in March. Shades of the old Prez Sez's. .when I get started, it just keeps flowing, ha!

Time to go out and chop some more firewood. Hi to all the Rats. I'll probably be in the area in April on the way to Dayton; Till then

73, Bill, W3HQT

Jan Contest: 6M: 18 in 12, 2M: 90 in 19, 220: 19 in 9, 432: 18 in 11, 1296: 3 in 2
Final Score: 10,282

* * *

Lee's Fillers

"AVERAGE" is as close to the bottom as to the top.

Remember, experience is yesterday's answer to today's problems.

and finally, FAULTS are the easiest thing to find.

DELAWARE VALLEY COUNCIL OF RADIO CLUBS

The first meeting of the Council was called by Edith, W3AAU, in the hamshack at the Naval Depot on Oxford and Martins Mill Road at 8:00 pm on January 16, 1986. Twelve hams attended this meeting, representing more than twelve clubs, because most hams belong to more than one club.

The Council Can assist in the coordination of the effort of member clubs for the following: VEC Exam Scheduling; Newsletter coordination; Service projects---non-emergency, such as marathons; Speakers Bureau; Program Pool; Exchange of Club Activities; Amateur Radio Demonstrations; Legal Problems; Public Relations.

It was agreed that organization of the Council should proceed along the following lines:

The objective of the Council is to lend such aid as possible in developing the Amateur Radio Clubs in the Delaware Valley (including Pennsylvania, New Jersey and Delaware) along progressive lines; and to promote friendly relations and cooperation among the Clubs in the area; to take general interest in all matters and problems affecting or involving Amateur Radio; and take such action as may be deemed appropriate.

The Council shall be made up of representatives of each club that wishes to join. Each Club shall appoint a delegate and an alternate. Each Club will have one vote. A quorum of twenty-five percent of the member Clubs is required and a majority of voting members present will prevail.

Frequency of meetings will be determined later.

An organization meeting is to be called for March 2, 1986 at 4 P.M. at the Naval Depot Cafeteria to elect officers and draw up Operating Guidelines.

NOTICE TO ALL CLUBS -- Please cover this matter with your board and appoint a delegate and alternate to attend the meeting on March 2nd. Contact Edith, W3AAU at 215-464-2665 for information.

Please have your group represented.

Respectfully submitted, Dave, KA3FVB, Acting Secretary.

* * *

AMATEUR RADIO ADVANCED CLASS LICENSE COURSE TO BE OFFERED AT PENNRIDGE EVENING SCHOOL

A course leading to the Advanced Class Amateur (Ham) Radio License will be offered in the Spring 1986 session of the Pennridge Area Evening School. The ten-week course will be offered on Monday evenings, beginning March 3.

Students in this course should already hold the Technician or General Class Amateur Radio License, and be able to copy International Morse Code. The code speed requirement for this Advanced Class License is 13 words per minute.

The instructor for the course is Robert Garland, a Telford resident licensed as a Ham Radio Operator since 1963. Mr. Garland previously taught Ham Radio classes at Souderton Evening School, and at the U.S. Coast Guard Training Center in New York City.

The text for the course will be the Amateur Radio Advanced Class License Manual published by the American Radio Relay League. The approximate cost of the text is \$5.00. No code practice will be offered as part of the classroom instruction. However, students will be assisted in obtaining code practice material for use outside of class.

Registration information may be obtained by contacting the Pennridge Evening School, Central Jr. High School, N. Fifth Street, Perkasia, PA 18944, telephone (215) 257-5011.

* * *

NOTE: South Jersey Radio Association is and will be celebrating their 70th birthday. I think this is the oldest Radio Club in the country. Let's all send them a great big best wishes....

TID BITS

Sunspot No. for January 1986 = 2.3 - Smoothed Number for July 1985 = 16.9.

Chuck, WA3IAC and his harmonic Angie were visitors at the February 20, 1986 meeting.

It was good to see K3VIT, Tom Jenkins at the meetings. Tnx to George, WB3IGR for providing transportation.

We missed K3BRS, Al Whiting who usually comes up from Washington, D.C. for our Homebrew Nite. Where were you, Al?

* * *

PUBLICATIONS UPDATE

Paul Rinaldo, W4RI of ARRL Headquarters advises that QEX is upgrading starting with the March issue. QEX will carry a monthly VHF/UHF column by Bill Olson, W3HQT. Geoff Krauss, WA3GFP's "VHF & Technology" will continue as a bimonthly column. An ARRL member can receive 12 issues for \$6.00 subscription. Non-Member \$12.

U.K. 6 Metre Group Newsletter ("Six News") Drop GW8ZCP, Maureen Wright, who is the Editor, if you are interested in a subscription. Cost is around \$5.60. Jay, KS2T reports their last issue No. 12 had over 50 pages (Tnx Jay for this info)

W3IIT, Harry Brown reports Debus is a VHF and above magazine published in Germany. It has been imported since last Spring by KA0HPK and was \$11.50 per year. The magazine is published quarterly with approximately 100 pages per issue. All technical articles are in English as well as German. Many columns of interest are: Microcomputer; Microwave; Tropo; Meteor Scatter, Aurora, and EME.

"VHF/UHF and Above Information Exchange" is the main publishing effort by KA0HPF. Rusty publishes it monthly and it is primarily for W/VE amateurs. Regular colums include "On 432" by K1FO, "432 and above EME News" by K2UYH, "220 News" by WOSD, Station Reports, Grid Squares, as well as technical articles, and photos of shacks and antennas. Subscriptions should be sent to: VHF/UHF and Above, P.O. Box 270, W. Terre Haute, IN 47885. Rates are \$8 for 6 mo/\$15 for 12 months for VHF/UHF and Above. Include your call and grid square with your address.

* * *

HOME BREW NITE PRESENTORS

K3GAS, Doc - Crystal activity tester/signal generator. Sound controlled Robot (Robotnic)
Awarded - "Most Unusual"

WA3IWT, Rich - 220, 432, 1296 Transverters
Awarded "Best Technical"

WA3JUF, Dave - 1296 Power Amplifier; 2304 Linear Amplifier; 2304 Mobile Transceiver
Awarded - "Best Construction"

WA2OMY, Gary - 2304 Linear Transverter; 144 Mhz - Linear Amplifier
Awarded - "Best Conversion"

WA3AXV, Ron - Homebrew Software - NBS Program for Scaling Antenna Design
(C-64 Computer)
Awarded - "Most Unique"

WA3AQA, Walt - 6 mtr Signal Source - That Didn't work.
Awarded - "Most Miserable Failure"

* * *

SWAP SHOP

WANTED: Drake RV-75 VFO, Kenwood HC-10 clock, 2 mtr. all mode.

FOR SALE: Collins "S Line". All round emblem 32S3 xmtr, 516 F2 pow supply, 75S3B (4 filters) 312B3 spkr \$850. Drake TR5 xcvr incl's 10-160 mtrs + warc bands NB & CW fil. mic 7077 by Drake & HD-1144 ps (20 amps) by Heath... excel condx. \$515. Icom IC-211 2 mtr all mode w/mic \$295. Drake MN75 ant tuner 300 watt wire or coax 1.8 to 30 mhz \$159. Drake AK-75 wire antenna 1.8 to 30 Mhz \$35. Drake TR5 xcvr incl's NB, CW fil. & HD1144 ps 20 amp \$500. Covers 160 mts to 10 & New Warc bands. Kenwood TS120 xcvr 10 thru 80 meter vy good condx \$340. Special closeout on Drake AK-75 wire ant. 1.8 to 30 Mhz \$35. MN-75 ant tuner 1.8 to 30 Mhz \$190. Icom R-70 gen. coverage rece (Mint) \$450.

CONTACT: Tony Musero, K3UKW
1609 S. Iseminger St.
Phila., Pa. 19148
215-271-8898

FOR SALE: Cannon TX 35 MM slr camera mint cond. includes 50mm and 80-210mm zoom lenses \$110; computer AMPRO little board based Z-80 CPM two DDDS drives much software includes ADDS Viewpoint terminal avail. complete or components; two 8" DDDS disk drives Shusart SA-850 \$75@/\$130 pr; four new 175-80 R13 snow tires mounted on Subaru painted steel rims \$75 pr/ \$130 all four.

CONTACT: Bruce Loss, WA3YUE
Phone: 215-542-6405 work
215-947-4166 Home

FOR SALE: Rohn 68 ft. fold-over tower w/all necessary accessories. Will sell or trade for a Drake "C" line. Make offer.

CONTACT: Dan, N2ASC
Phone: 609-871-3044

FOR SALE: Hy-Gain CD 4-5II rotator w/control box & 80 ft. of control cable \$100; Alinco EPS-110M 10 amp. supply \$45; Cushcraft 2 mtr ringo ranger \$15; Cushcraft 220 Mhz ringo ranger \$15; Cushcraft 440 Mhz ringo ranger \$15; Isotron 80 mtr base/portable ant. \$25;

WANTED: 551 10 watt 6 mtr rig. Maverick 6 mtr. tunable low pass filter.

CONTACT: Harry Schools, KA3B
Phone: 215-468-1866

FOR SALE: G10 P.C. Board 6x6x1/16 - 50¢@ or .25/sq. in. .001/50 volts & .01/50 volts disc ceramic caps - 12¢@ or 15/\$1.

WANTED: Contacts on 10.25 Ghz FM on or before June contest.

CONTACT: Chuck, WA3IAC
Phone: 215-335-0637

FOR SALE: Gonset 6 mtr xc vr w/manual \$50; Heath sixer & book \$20. 4 ft. rack w/ 2 mtr AM xmtr, P.S. & modulator, 5894 final \$20; 6 mtr xmtr, 829 final w/P.S. & modulator plus relay control \$20; 432 converter (Parkes copy) \$25; tubes - all types. Funk & Wagnall 26 volumes encyclopedia \$15.

CONTACT: Doc Cutler, K3GAS
Phone: 215-635-1078

FOR SALE: Canon PC-20 personal copier, fully automatic, paper tray & cartridge. Will copy 8 1/2 x 11 down to business card - 20 lb. paper. Makes 1 to 19 copies - push button setting - used but in excellent condition. \$450. Color cartridges available.

CONTACT: Bill Soble, W3QXT
9357 Hoff Street
Phila., Pa. 19115
Phone: 215-676-6769

WANTED: Kenwood TV 506 6 mtr xverter - any condition.

CONTACT: Dave Hackford, N3CX
Phone: 215-679-7293
215-483-2030

* * *

COMMERCIAL AD

Loop Yagis: 902 Mhz and 1296 Mhz 45 element \$70; 2304 Mhz \$62.50. Also available assembled and tested. Power dividers, stacking frames available. Linear amplifiers; 1296 Mhz, 1 watt in 18 watts out \$230; 2304: 1 watt in, 10 watts out \$300. Write for more information to: Down East Microwave, Bill Olson, W3HQT, Box 1655A, RFD 1, Burnham, ME 04922 (207) 948-3741.

THE FOUNDATION FOR AMATEUR RADIO NEWS RELEASE

THE FOUNDATION FOR AMATEUR RADIO, INC., a non-profit organization with Headquarters in Washington, D.C. plans to award twenty-one (21) scholarships for the academic year 1986-87. The Foundation composed of fifty local area Amateur Radio Clubs, fully funds two of these scholarships from the proceeds of its annual Hamfest. It administers without cost to the donors seven (7) scholarships for the Quarter Century Wireless Association, two (2) each for the Dade (FL) Radio Club, the Baltimore (MD) Amateur Radio Club and the Department of State Amateur Radio Club and one (1) each for the Radio Club of America, the Richard G. Chichester Memorial, The Young Ladies' Radio League, the Edmund Redington Memorial, the Amateur Radio News Service and the Columbia (MD) Amateur Radio Association.

Licensed Radio Amateurs may compete for these awards if they plan to pursue a full-time course of studies beyond high school and are enrolled or have been accepted for enrollment in an accredited university, college or technical school. Most of the scholarships require the applicant to hold at least an FCC General Class license or equivalent. The scholarship awards range from \$350 to \$900 with preference given in some cases to residents of specified geographical areas or the pursuit of certain study programs.

Additional information and an application form can be requested by a letter or QSL/postcard, postmarked prior to May 31, 1986 from:

F A R Scholarships, 6903 Rhode Island Avenue, College Park, MD 20740

The Foundation is a 501(c)(3) organization devoted exclusively to promoting the interests of Amateur Radio and those scientific, literary and educational pursuits that advance the purposes of the Amateur Radio Service.

* * *

A MESSAGE FROM TAIPEI

"Back on the road again", Taiwan, Hong Kong & Japan. I have been very busy and not getting in too much Ham time.

I got on during the VHF contest for about 3 hours- 2 & 432. Out where I live you have to make 432 Mhz appointments; otherwise a dead spectrum. Our club just put a 444.875 Mhz Repeater on the air, so activity should pick up.

Pls say Hi to all the Rats - I will be active as JY9RB from 15 March until 21st on 20 Meters. Take care & best regards.

73/88 Dick WB9PUJ

* * *

330 mw Class 'A' Linear Amplifier for 2.3 GHz.

Gain > 10 DB RTL > 20 DB P_{sat.} ≈ 450 mw.

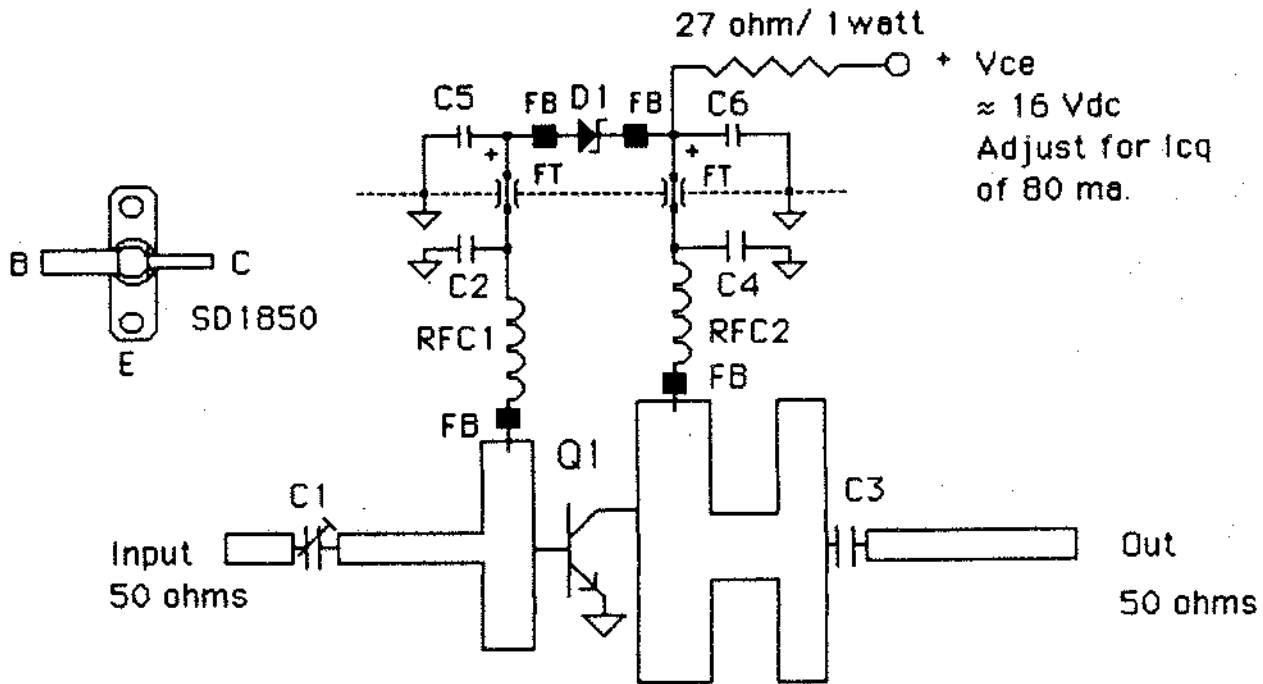

- C1 3pf Johanson Gigi-trim cap
 - C2,4 27pf - 100pf chip cap
 - C3 27pf chip cap
 - C5,6 10ufd/35 Vdc (6 Vdc ok for C5)
 - RFC1,2 2t, #28, 0.10" ID
 - D1 15 volt zener (1N4744A)
 - FB ferrite bead
 - FT 470pf - 1000pf feedthru
 - Q1 Thomson CSF Semiconductor SD1850
- Microstrip on 1/32" Teflon Er = 2.5
See full scale artwork

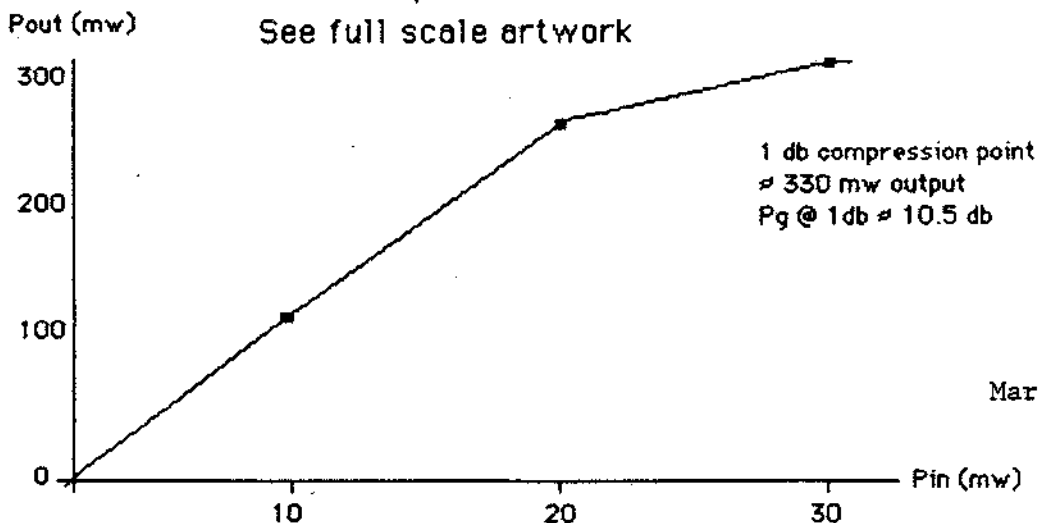
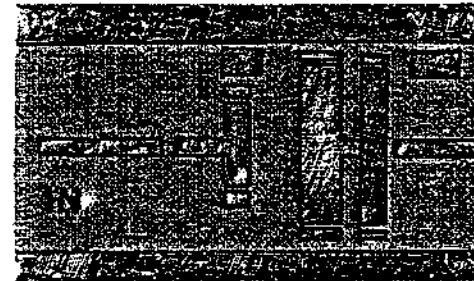

W3HQT 1984

Drawn by
WA3JUF 1985

March 1986 CHEESE-BITS



K3GAS



WA3IWT



WA3JUF

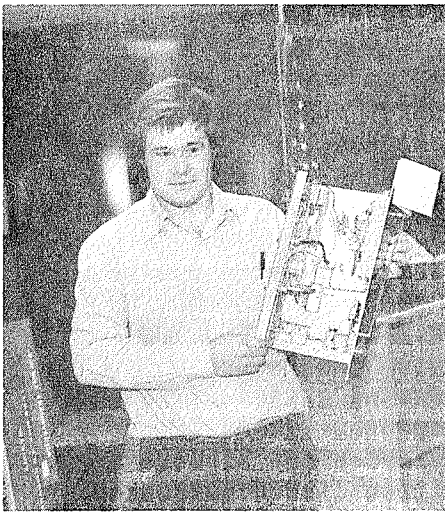

WA2OMY

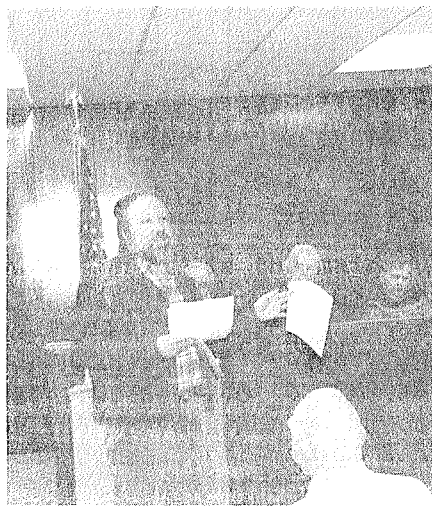

WA3AXV

The "Phantom"

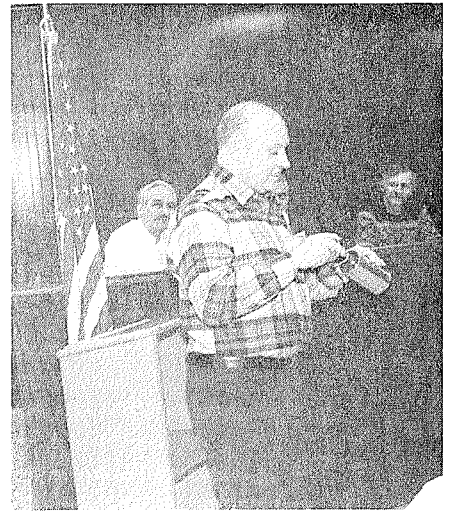

WA3AQA

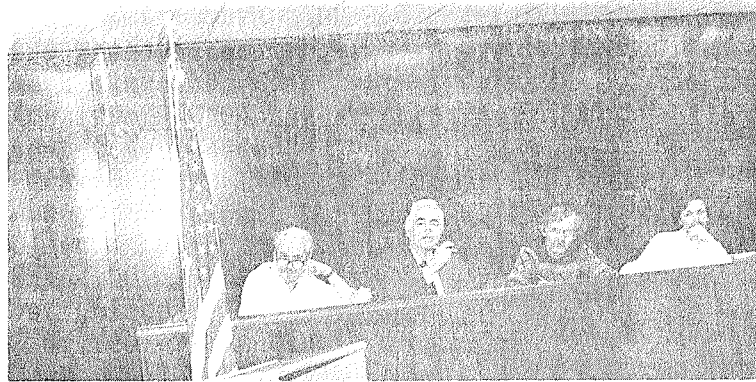

THE JUDGES - K3JJZ K31UV W3LIT - THE PREZ - WB2RVX

HOMEBREW WITE 1986

photos by WA3YUE

DOWN EAST MICROWAVE

BOX 1655A - RFD #1
BURNHAM, ME 04922

Microwave Antennas and Amplifiers
by W3BQT

902 1296 2304 3456 MHz.

Bill Olson (207) 948-3741

73 Amateur Radio's Technical Journal

PO BOX 931
FARMINGDALE, NY 11737

\$25 one year \$53 three years

NE 7-8328

GEORGE S. VAN DYKE, JR., P.E.
CONSULTING ENGINEER

W3HK

4607 CONVENT LANE
PHILA., PA. 19114



AMIL S. GUMULA
PRESIDENT

A. G. RADIO PARTS CO.
939 TOWNSHIP LINE RD.
ELKINS PARK, PENNA. 19117
TELEPHONE: 215-886-6100

RCA Authorized
Distributor

(302) 328-7728
ORDER LINE 800-441-7008



Delaware Amateur Supply
"AMATEUR SALES AND SERVICE"

PAUL WA3OPX
KATHY KA3IYO

71 MEADOW ROAD
NEW CASTLE, DELAWARE 19720

AMATEUR
SALES & SERVICE

(215) OL 9-5900

"HAM" BUERGER INC.
Communication Specialists

BOB HERSHMAN
WA3ZID

68 N. YORK RD.
WILLOW GROVE, PA. 19090

215-342-5982

WA3HIT

Paul and Betty Rilling

INCOME DIVERSIFICATION

5830 Weymouth Street -Phila., Pa.19120

The Ham Radio Publishing Group



Greenville, NH 03048 (603) 878-1441

HAM RADIO - the Technical Ham's
Magazine. Ask for a free sample
copy or our Book Catalog.

CALL DOC CUTLER (K3GAS)
FOR YOUR ELECTRONIC NEEDS

NEW, RECONDITIONED, OR AS IS.

LOW PRICES

by appointment

215-635-1078

CARL BARISH

**PRINTECH
PRINTING**

13820 NE 20th Suite D
Box 4247
Bellevue, WA 98009
746-6000



**NESHAMINY
TRAVEL
SERVICE**

Harrist Soltoff
Home: (215) 947-4483

xy1 K3IUV

2337 Neshaminy Blvd.
Bensalem, PA 19020

BROWSING - THURS. 7⁰⁰ - 8⁰⁰
SAT. 8⁰⁰ - 4⁰⁰

Day-Nite (215) 455-2121

FERTIK'S ELECTRONICS

Components & Equipment

LEON FERTIK

5400 ELLA STREET
PHILADELPHIA, PA. 19120

LUNAR, MICROWAVE MODULES, ARCOS, ASTRON, KLM
TAMA, TONNA F9FF

THE
VHF SHOP

TOM KQ3R
16 South Mt. Boulevard
Mountaintop, Pa. 18707

(717) 474-9399
M - F after 6:00 p.m.
Weekends Anytime!

EASTSIDE SURPLUS SALES

12894 NE 15th PLACE
BELLEVUE, WA 98005

(206) 453-0795

Carl Barish
KC7ZC

A CANDY STORE OF PARTS FOR THE EXPERIMENTER.

(302) 328-7728
ORDER LINE 800-441-7008



Delaware Amateur Supply
"AMATEUR SALES AND SERVICE"

ROB WA3QLS
GAIL KA3ITN

71 MEADOW ROAD
NEW CASTLE, DELAWARE 19720



TAPPER

Gibson

MAYTAG

FEDDERS

Jenkintown & Glenside Electric Co.

WA3WLQ

220 YORK ROAD
JENKINTOWN, PA.
Turner 4-0375 - 4-1050
WA 7-4325

"HAM" BUEGER, INC.
 Electronic Equipment Distributor
 "Right in the middle of a lot of good company!"
 68 N. YORK ROAD
 WILLOW GROVE, PA 19090
 215-659-5900
 Service Since 1956

If we're judged by the company we keep, we should do pretty well!



Weller **TPC** **GILFER LMB** **n-te** **CDP** **Saxton** **ICOM** **CES**

W2AU **HAM-KEY** **ROHN** **ASIATIC** **Miller** **DRAKE** **Midcor** **hig-gain** **Larsen Antennas** **Beamcat** **South River** **VIBROPLEX** **MBC** **TRW** **TAB BOOKS** **Keefenach** **CUSHCROFT** **AMPHENOL** **SPRAGUE** **THE MAKE OF RESISTANCE** **TELEX** **Wilson Electronics Corp.**

AMP SPECIAL INDUSTRIES **COVER CRAFT** **SWAN** **AMECO** **BOMAR** **phelps dodge** **COMMUNICATIONS COMPANY** **MISCO** **Vector** **HUSTLER** **Waldom** **calbook** **Weller** **TPC** **GILFER LMB** **n-te** **CDP** **Saxton** **ICOM** **CES**

Cheese Bits
 2087 Parkdale Ave.
 Glenside, Pa. 19038

MEETING NOTICE



MT. AIRY VHF RADIO CLUB, INC.

PACK RATS

FIRST CLASS