

# PACK RATS'



## PACK RATS

CLUB CALL: W3CCX

MT. AIRY VHF RADIO CLUB, INC.

# CHEESE BITS



MT. AIRY VHF RADIO CLUB., "THE PACK RATS", PHILADELPHIA, PA. W3CCX  
NET FREQUENCIES: 50.125, 144.150, 222.125, 224.58/222.98, 432.110, 903.100, 1296.100 MHz  
AFFILIATED CLUB: AMERICAN RADIO RELAY LEAGUE ARNS

Meetings: Third Thursday of each month at 8:00 PM  
Southampton Free Library, 947 E. Street Road  
Southampton, Pennsylvania 18966

SCANNED TO PDF BY BERT, K3RUV, 2013

VOLUME XXXIV

JULY 1992

NUMBER 6

### THE PREZ SEZ

Hi all. A year has passed since I took office. I want to reflect on the accomplishments of our club and the direction we may want to go in the future. I believe that we as a club are at a crossroads. A number of our older members are no longer able to actively participate in club functions and activities. Those of us who are still active have our time divided between family and work. Sometime this leaves little or no time for the hobby. Some are just burned out 20 plus years of contests and new bands have taken a toll. Two of our members W3CL and W3ZD who were major contributors are now silent keys.

However one always has the tendency to overlook the positives. We have another January contest gavel. We are attracting new members. We accomplished a major move of Hamarama and the VHF conference to a new location. And most importantly we continued as a major player in the VHF/ Microwave field of Amateur Radio.

We should not take for granted that the gavel will always be ours. But at the same time take pride in our accomplishments. Change is something that we cannot control. But we do have control of our own destiny. Contest rule changes may require a change in the way we all operate the contest. If so we look forward to the challenge. But now is the time to plan for and make the necessary improvements to assure continued success in January. This is addressed to all active members regardless of past contest scores. Let us all strive to help each other improve our home stations and find time to get on the air.

It was my pleasure to serve as your President over the past year.

William T. Murphy  
WORSJ, FN20JR

Pack Rats CHEESE BITS is a publication of the Mt. AIRY VHF RADIO CLUB, INC. Philadelphia, PA. and is published monthly.

SUBSCRIPTION RATE: \$10.00 PER YEAR.

We operate on an exchange basis with other publications. Anything that is printed in CHEESE BITS may be reprinted, unless otherwise stated, provided proper credit is given.

DEADLINE FOR ARTICLES AND SWAP SHOP IS THE MONTHLY MEETING DATE. NON-COMMERCIAL SWAP SHOP ITEMS-FREE OF CHARGE.

SUBSCRIPTION/ADVERTISING MANAGER:

Bob Fischer, WB2YEH  
7258 Walnut Avenue  
Pennsauken, NJ 08110  
(609) 665-8488

EDITOR:

Harry Brown, W3IIT  
3012 Potshop Road  
Norristown, PA 19403  
(215) 584-4846

CLUB TREASURER:

Dave Mascaro, WA3JUF  
1603 Mink Road  
Ottsville, PA 18492  
(215) 795-2628

AWARDS CHAIRMAN:

Joe Kilgore, W2EIF  
(609) 783-9478

TRUSTEE OF CLUB CALL - W3CCX

Ron Whitsel, WA3AXV  
(215) 355-5730

PACKRAT 222 MHz REPEATER - W3CCX/RPTR  
222.98/224.58 MHz, Churchville, PA

OFFICERS: 1991-1992

PRESIDENT: W0RSJ, Bill Murphy  
VICE-PRES: WB3JYO, Paul Drexler  
REC. SECR: WA3AQA, Walt Zumbach  
TREASURER: WA3JUF, Dave Mascaro  
COR. SECY: WA2GFP, Geoff Krauss  
DIRECTORS: N3AOG, Dick Comley (1 YRS)  
WA3NUF, Phil Miguez (1 YRS)  
N3EXA, Brian Taylor (2 YRS)  
K3ESJ, Bill Jaxheimer (2 YRS)

MONDAY NIGHT NETS

<u>TIME</u>	<u>FREQ.</u>	<u>NET CONTROL</u>
7:30 PM	50.125 MHz	K3EOD
8:00 PM	144.150 MHz	W2EIF
8:30 PM	222.125 MHz	WB2YEH
8:30 PM	224.58R MHz	K3ACR
9:00 PM	432.110 MHz	WA3AXV
9:30 PM	1296.100 MHz	WA3NUF
10:00 PM	903.100 MHz	N3AOG

COMMITTEE CHAIRMEN

LADIES' NIGHT: WA3YUE 215-666-1558  
JUNE CONTEST: N3CX 215-679-7293  
HAMARAMA: K3EOD 215-742-3312  
VHF CONFERENCE: KB3XG 215-766-2643



THE AMERICAN RADIO RELAY LEAGUE **OST**

**HUGH A. TURNBULL, W3ABC**  
Director, Atlantic Division

8903 RHODE ISLAND AVE.  
COLLEGE PARK, MD. 20740 (301) 927-1787

1-302-478-2757

**AMATEUR  
and  
ADVANCED  
COMMUNICATIONS**

*"Gisele"*  
/K3WAJ

G. B. WALLS 3208 CONCORD PIKE (RT. 202)  
WILMINGTON, DEL. 19803

Graphic Design Illustration Production



**Lynne D. Whitsel**

209 Frog Hollow Road  
Churchville, PA 18966  
215 355-5730

Calendar of Coming Events- July 1992

July

- 4 Independence Day
- 5 13th Annual Wilkes-Barre Murgas ARC K3YTL Hamfest and Computerfest will be held at the Luzerne County Fairground on Rte 118 in Luzerne, PA. TI on 146.61R and .52. VE Exams.
- 4 Harrisburg Hamfest at the Bressler Picnic Grounds, take exit 1 off I 283, follow PA 441 and signs. Admission: \$3. Talk-in on 147.30/.90 and .52.
- 9 Packrat Board of Directors meeting will be held at the QTH of Bob, W3GXB at 8:00 PM. All interested parties welcome. Call 215-346-8698 for directions. See directions below.
- 11-12 CQ Worldwide VHF QPX Contest. See June CQ Magazine page 60 for rules r June QST page 83. Contest runs from 0000Z, 14 July to 2400Z on 15 July (48 hours). All bands from 50 MHz up.
- 12 Sussex County ARC Hamfest at the Sussex County Fairgrounds, Plains Rd. off Rte 206 in Augusta, N.J. Talk-in on 147.90/.30, 146.52, and 222.90/224.50.
- 16 July meeting of the Packrats will be the Annual White Elephants Sale at Gary's Glen, the QTH of Gary, WA2OMY at 8:00 PM. All interested parties welcome. Call 215-539-6409 for directions. See directions below.
- 16-19 The 26th Annual Central States VHF Conference will be held in Kerrville, Texas at the W. O. Hilton Hotel. For further information, send an SASE to Larry Hazelwood, W5NZZ, P.O. Box 54437, Oklahoma City, OK 73154.
- 25 Lancaster, PA. Red Rose Repeater Assn Hamfest will be held at the McCaskey High School, exit Rte 30 at Hwy 23W. TI on 147.615/015.
- 26 BRATS Hamfest, Timonium, Md. at the Timonium Fairgrounds, located on York Rd. adjacent to I-83 near I-695. Talk-in on 147.63/.03, and 146.52. Admission 5\$.
- 30-Aug 2 The Fifth Annual 70 cm and Up Moonbounce Conference will be held in Thorn, The Netherlands. For info, contact Russ Miller, N7ART at 206-630-0301.

Aug

- 1-2 ARRL UHF Contest. For rules see July QST, page 97. All bands from 222 MHz and Up.

DIRECTIONS: W3GXB, Bob's QTH - 1449 Maple Road, Kintnersville, PA. Take Rte.611 north of Doylestown to just north of Ottsville. Take a left on Rte 412, then go approx. 7 miles and turn right on Stoney Garden Road. Turn right after approx. 1/2 mile onto Maple Ave. About 1/4 mile on the right will be Bob's QTH.

DIRECTIONS: WA2OMY, Gary's QTH - 39 W. Mt. Kirk Ave Norristown, PA. Take Ridge Pike (also known as Main St. In Norristown) north of Norristown past Trooper Road. Continue approx. 1 mile to Mt. Kirk Ave and turn left. The landmark on this corner is Gary's Drug store (no relation). Gary's QTH is about 5 houses on the right after you turn. Parking is limited so carpool or park in the drug store parking lot. Bring chairs.

## MID-ATLANTIC VHF CONFERENCE

The Annual Mid-Atlantic VHF Conference will be held on Saturday, October 3, The day before our annual hamfest. John Sorter, KB3XG, is again chairman of the conference. If you would like to present a paper at the conference or know of someone that might, please contact John as follows:

John Sorter, KB3XG  
5290 Stump Road  
Pipersville. PA 18947  
(215) 766-2643

## The Propagation Report for 5/14/92 to 6/17/92

By Bill Murphy, WØRSJ

The six meter band has been open due to E skip for considerable periods of time over the past month. On May, 25 the band opened at 1800 GMT with EM19, EM37, EM48, EN10, EM09, EM18, EN31, EN14, EM77 and EM45 worked between 1900 and 0045 in FN20. In addition a brief double hop contact occurred with WA6BYA in CM87. As the month progressed six was open almost every day. This past weekend, the VHF QSO PARTY was run and band conditions were excellent with the band opening on 13 June. This opening was sporadic E with some double hop to the Pacific NW. W3CCX located in FN21 reported working 186 grids on six and 55 on the two meter band in the contest. Conditions were reported to be good on all the microwave bands. The only complaint was that activity was low. One of the highlights of the contest was a narrow band 10GHZ SSB contact between W3CCX and K2UYH over a partially obstructed path. This was witnessed by a number of Pack Rats who I hope will be putting 10 GHZ on the air soon from there home QTH's. Al is on from his home location using waveguide to his dish.

## TID-BITS

Deac, W3AJF recently celebrated his 88th birthday. Congratulations from all of us.

All VHF and above amateurs interested in the use of "our" bands are recommended to read an article entitled "Committee Studies ARRL VHF Band Planning" by Kay Craigie, WT3P, on page 43 of the July 1992 issue of QST.

A new newsletter, "Upper Midwest VHF/UHF Newsletter" is being published by Rich Westerberg, NOHJZ. For information contact Rich at 17500 Cherry Lane, Eden Prairie, MN, 55346.

## HAMARAMA '92

By Al Boblitt, K3EOD

Believe it or not, October is only a few months away and with it brings HAMARAMA and the VHF Conference. HAMARAMA supports our club with the necessary funds to run the club for the next year. It is therefore imperative that each and everyone of us either chairs one of the various committees or signs up to work on a committee.

Approximately 2,000 HAMARAMA flyers have been distributed at various hamfests already. Additional flyers are still available to be given out at future hamfests. Please contact me if you are planning to attend any hamfests in the future so I can give you a supply of flyers to be handed out.

Let's make HAMARAMA '92 the biggest and best hamfest on the east coast.

Dear Pack Rats

My children and I want to thank all of you who attended Dave's Memorial Service and especially those who were kind enough to give witness to a wonderful person. It was very therapeutic to greet all of you and share some special feelings. Even though we moved far away he missed all his friends "back home" and he looked forward to and relished the contacts he made with you on the air. He had great plans for future contacts after he installed the new antenna this spring. In his last letter to our son, Mark, in Nepal, he mentioned future possible contacts with Father Moran, the "ham" priest in Nepal. As it turned out, Father Moran was Mark's patient in Mark's Hospital in Kathmandu in April. He died 12 days later after being moved to a bigger hospital in India. We can only surmise that they "made contact" later along with the other "silent keys", Harry, Doc, Lee and Mario.

Thanks again to all of you and remember to look me up if you're in the Lake Tahoe area.

73's

Jane Zimmerman, WB3DSK

HARRY B. STEIN - MEMORIAL TREE FUND

By Al Boblitt, K3EOD

On behalf of the Stein family, I would like to personally thank the following Pack Rats and friends of Harry Stein for their generous contributions to the HARRY B. STEIN - MEMORIAL TREE FUND.

The contributors are: K3AJS, N3AOG, WA3AQA, K3BPP, N3CX, W3CXU, K3DLS, K3DMA, WA3EHD, W2EIF, K3EOD, K3ESJ, WA2GFP, W3GXB, W3HK, N3ITT, K3JJZ, WA3JUF, KD6KD, W3KKN, WA3MGB, W3NSI, WA3NUF, WA2OMY, K3PHY, WB9PUJ, WORSJ, K3VEQ, WB2VLA, WB2YEH, AND W3ZD.

We are pleased to announce that we have received contributions totaling \$560.00 and have purchased 80 memorial trees which will be planted in Israel in Harry's name. It is fitting that we have purchased 80 trees in Harry's name, one for each of the 80 years that Harry brought Love, Joy, Friendship and Happiness into each of the many lives that he touched. Harry will be greatly missed.

If you have not done so, and would like to make a contribution in Harry's name (to any charitable organization of your choice) or send a check payable to: The Jewish National Fund (each tree costs \$7.00) c/o Old York Road Temple Beth Am, 971 Old York Road, Abington, PA. 19001, Attn: Hanna

For some of the newer club members who may not know who Mario Fontana, K3UJD, was and what the Mario Award established to honor his effort was, the following announcement is reprinted from the December 1974 issue of Cheesebits.

THE MARIO AWARD ESTABLISHED

(Prepared by Tony Souza, W3HMU)

1. The Mario Award will be given by the Mt. Airy VHF Radio Club in memory of Mario Fontana, K3UJD whose technical leadership and generous assistance with amateur radio construction projects are greatly missed by the membership.
2. The Mario Award will be presented to a member or group of members of the Mt. Airy VHF Radio Club selected by the club's Board of Directors.
3. The Mario Award will be presented for the purpose of honoring a member or group of members who have enriched the enjoyment of VHF radio by the amateur fraternity through the unselfish donation of technical services including time and talent.
4. The Mario Award will not be presented more than once per year nor less than once in five years. It is the intention of the award committee that the Mario Award be presented only in outstanding circumstances and not be diminished in value by annual use.
5. The recipient(s) of the Mario Award will be presented a letter of commendation and an engraved plaque.

JUNE ELECTION for 1992-92 CLUB OFFICERS

The June elections are over and the new officers for July 1992 thru June 1993 are as shown below. The nominating committee and all club members would like all that volunteered to run this year and to thank all ex-officers that are now free to get on the air and work on their list of projects. Nominations were so successful this year that there was actual competition for three offices including President.

President:	Bill, WØRSJ
Vice President:	Paul, WB3JYO
Treasurer:	Dave, WA3JUF
Recording Secretary:	Walt, WA3AQA
Corresponding Secretary:	Geoff, WA2GFP
Directors:	Bill, K3ESJ
	Brian, N3EXA
	Dick, N3AOG
	Phil, WA3NUF

SWAP SHOP

Send non commercial swap shop items to the editor.

For Sale: Rohm HBX Tower, 56 ft., free standing, good condition  
Call Dave Volak, 215-847-5255.

COMMERCIAL AD

LOOP YAGIS: 902 MHz 33 element \$89 kit, \$109 assembled and tested. 1296 MHz 45 element, \$89 kit, \$109 assembled and tested. 1296 MHz 55 element "Sooper Looper" \$99 kit, \$124 assembled and tested. 2304 MHz 45 element \$75 kit, \$89 assembled and tested. Also available: element and hardware kits for the above. 2 and 4-way power dividers. Discount on complete arrays. Solid State Linear Power Amps, 13 VDC: 1296 - 8W in 35W out \$315, 1W in 20W out \$265, 4W in 70W out \$695. GaAs FET Preamps: 903 MHz .8dB NF \$90, 1296 MHz .8 dB, 2304 MHz 1 dB max NF \$140. SHF SYSTEMS No-tune Transverter kits, w/144 MHz IF now available for 903 through 3456 MHz. Write or call for complete catalog. DOWN EAST MICROWAVE, Bill Olson, W3HQT, Box 2301 RR-1, Troy, Maine. For information and orders telephone (207) 948-3741.

CHEESEBITS SUBSCRIPTIONS

Cheesebits subscriptions are available to everyone interested in activities and information from the VHF thorough the microwave frequencies. Subscriptions are for 1 year of 12 issues. For a subscription, send the following information:

----- Name: \_\_\_\_\_  
Name: \_\_\_\_\_ Call: \_\_\_\_\_  
Street Address: \_\_\_\_\_  
Town: \_\_\_\_\_ State: \_\_\_\_\_ ZIP: \_\_\_\_\_  
Subscription Rate: \$10.00 per year

Send to: SUBSCRIPTION/ADVERTISING MANAGER:  
Bob Fischer, WB2YEH  
7258 Walnut Avenue  
Pennsauken, NJ 08110

### Andrew Coaxial Cable Information

Have you ever wandered thru a hamfest and spotted some neat looking coax and were unsure of what it was? It says Andrew and you know that this is good but how good is it? Worth the \$1.00 a foot? Here's a quick guide to some of the more common Andrew coax that you may come across, attenuation and common connectors to look for. It's frequently the connector part that's tough to find -especially at a reasonable price. As a reference, Belden 9913 is shown. Note that it runs around \$0.60 per foot.

Andrew Part No.	Size	Dielectric	Connector*	Attenuation in dB/100 feet		
				100 MHz	1000 MHz	2000 MHz
LDF4-50A	0.50 in.	Foam	L44W	0.685	2.34	3.45
LDF5-50A	0.875 in.	Foam	L45W	0.369	1.31	1.97
LDF6-50	1.25 in.	Foam	L46W	0.275	0.967	1.45
LDF7-50A	1.625 in.	Foam	L47N	0.225	0.819	1.25
HJ4-50	0.50 in.	Air	74AW	0.83	2.65	3.85
HT5-50	0.875 in.	Air	75AW	0.419	1.78	2.91
HJ5-50	0.875 in.	Air	76AW	0.57	1.27	
HJ7-50A	1.625 in.	Air	87N	0.207	0.70	
HJ8-50b	3.00 in.	Air	EIA Flange	0.14	0.34(450MHz)	0.56(1 GHz)
Belden 9913 Reference				1.4	4.5	13.0 at 5 GHz

\* Standard Andrew connectors have a suffix of W for Male or N for female. Connectors listed here are all type N except for the EIA flange. Andrew makes many types of connectors from type F on but most VHF applications call for type N.

Attached are attenuation curves for common Andrew air and foam dielectric cables.

### Tropo Hunters Frequency Guide

For those interested in monitoring the TV channels for propagation, here's a chart that may be useful in deciding what bands may be open.

### TV CHANNEL vs FREQUENCY

TV CHAN	FREQ. MHz	TV CHAN	FREQ. MHz	TV CHAN	FREQ. MHz	TV CHAN	FREQ. MHz	TV CHAN	FREQ. MHz	TV CHAN	FREQ. MHz
2	54-60	16	482-488	30	566-572	44	650-656	58	734-740	71	812-818
3	60-66	17	488-494	31	572-578	45	656-662	59	740-746	72	818-824
4	66-72	18	494-500	32	578-584	46	662-668	60	746-752	73	824-830
5	76-82	19	500-506	33	584-590	47	668-674	61	752-758	74	830-836
6	82-88	20	506-512	34	590-596	48	674-680	62	758-764	75	836-842
7	174-180	21	512-518	35	596-602	49	680-686	63	764-770	76	842-848
8	180-186	22	518-524	36	602-608	50	686-692	64	770-776	77	848-854
9	186-192	23	524-530	37	608-614	51	692-698	65	776-782	78	854-860
10	192-198	24	530-536	38	614-620	52	698-704	66	782-788	79	860-866
11	198-204	25	536-542	39	620-626	53	704-710	67	788-794	80	866-872
12	204-210	26	542-548	40	626-632	54	710-716	68	794-800	81	872-878
13	210-216	27	548-554	41	632-638	55	716-722	69	800-806	82	878-884
14	470-476	28	554-560	42	638-644	56	722-728	70	806-812	83	884-890
15	476-482	29	560-566	43	644-650	57	728-734				

## MODIFICATIONS FOR THE SHF SYSTEMS 540 MHz LO

Several people have experienced local oscillator instability problems on the SHF Systems 3456 transverter board when driven by the SHF 540 MHz LO. The 540 MHz LO generates +16 dBm (40 mW) by using an MAV-11 MMIC at its output. This LO level may be insufficient to properly drive the 3456 multiplier chain, resulting in oscillations in the MAR-08 MMIC's. This instability may be eliminated by increasing the 540 MHz LO level. The LO output may be easily increased to greater than 100 mW by substituting a Thomson TRF-559 bipolar transistor for the MAV-11 on the 540 LO board.

Remove the MAV-11 and enlarge the MMIC mounting hole to allow the TRF-559 to sit in the hole flush with the PC board. Solder the emitter leads to the adjacent ground pads and place an additional "wire-thru" ground close to the transistor. Use an ATC "B" or similar capacitor for the RF bypass soldered upright on the adjacent ground. A 20K 1/4 watt resistor is soldered from the top of the RF bypass to the transistor base lead.

WB3JYO 1-91

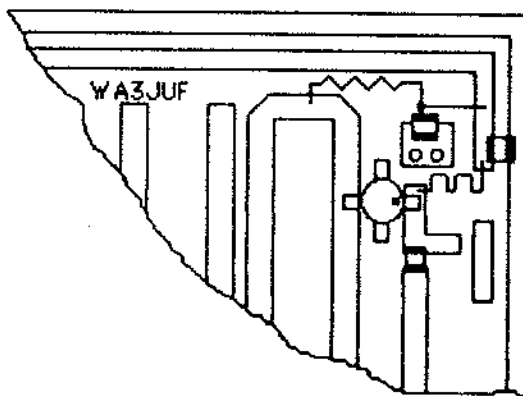
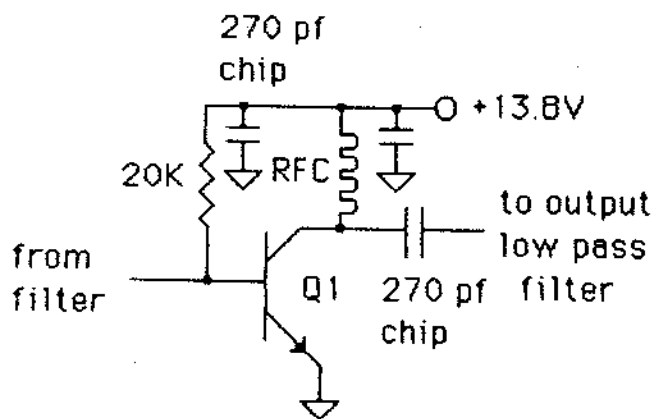

Q1 TRF559, MRF559  
RFC 6t, #22, 1/8" ID



**HELIAX® Coaxial Cable**  
Air-Dielectric Attenuation

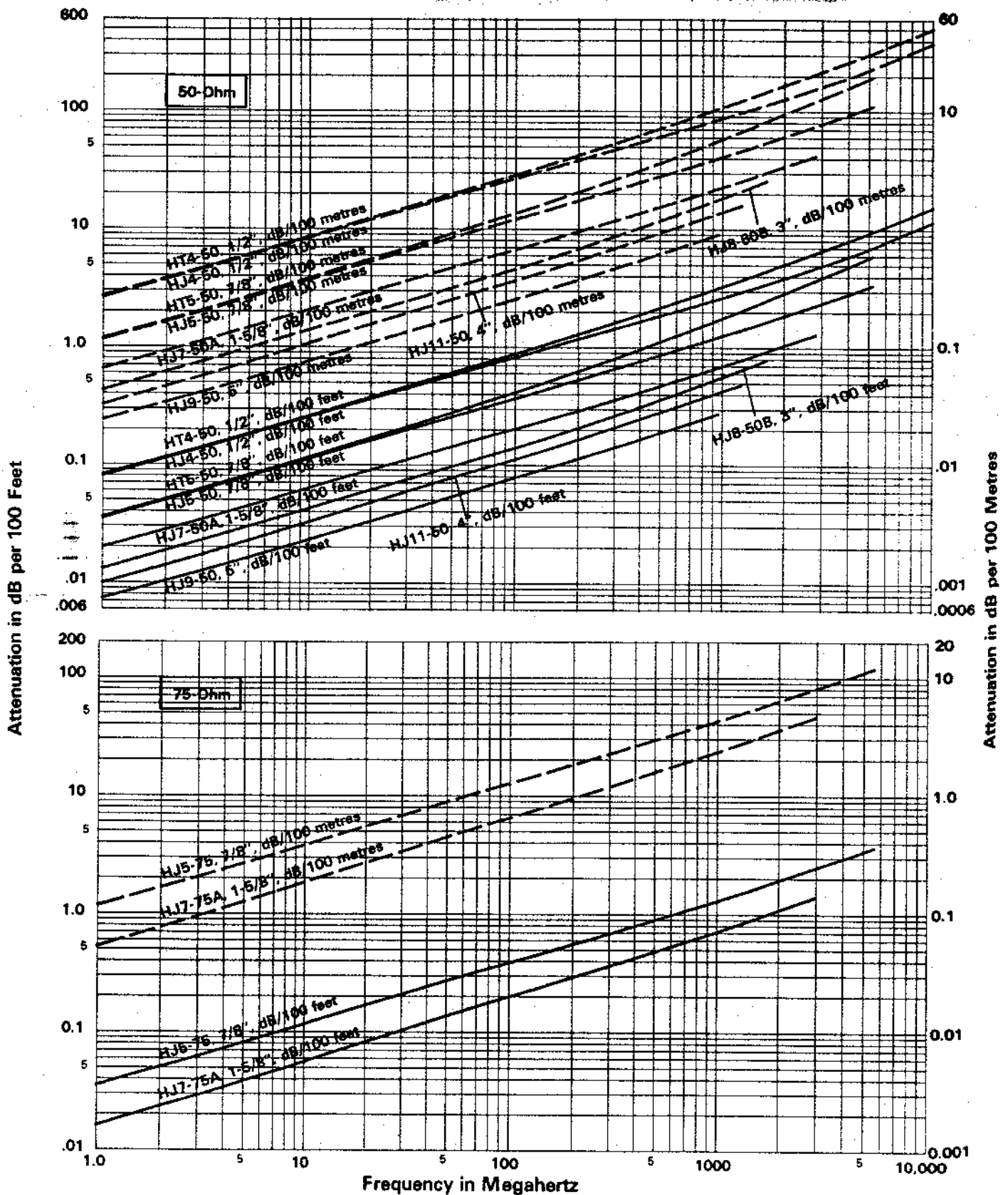

Attenuation Curves based on:  
VSWR 1.0  
Ambient Temperature 24°C (75°F)  
Atmospheric Pressure, dry air

Conversion Data:  
For other ambient temperatures, see curve on page 219.

Foam-Dielectric Attenuation

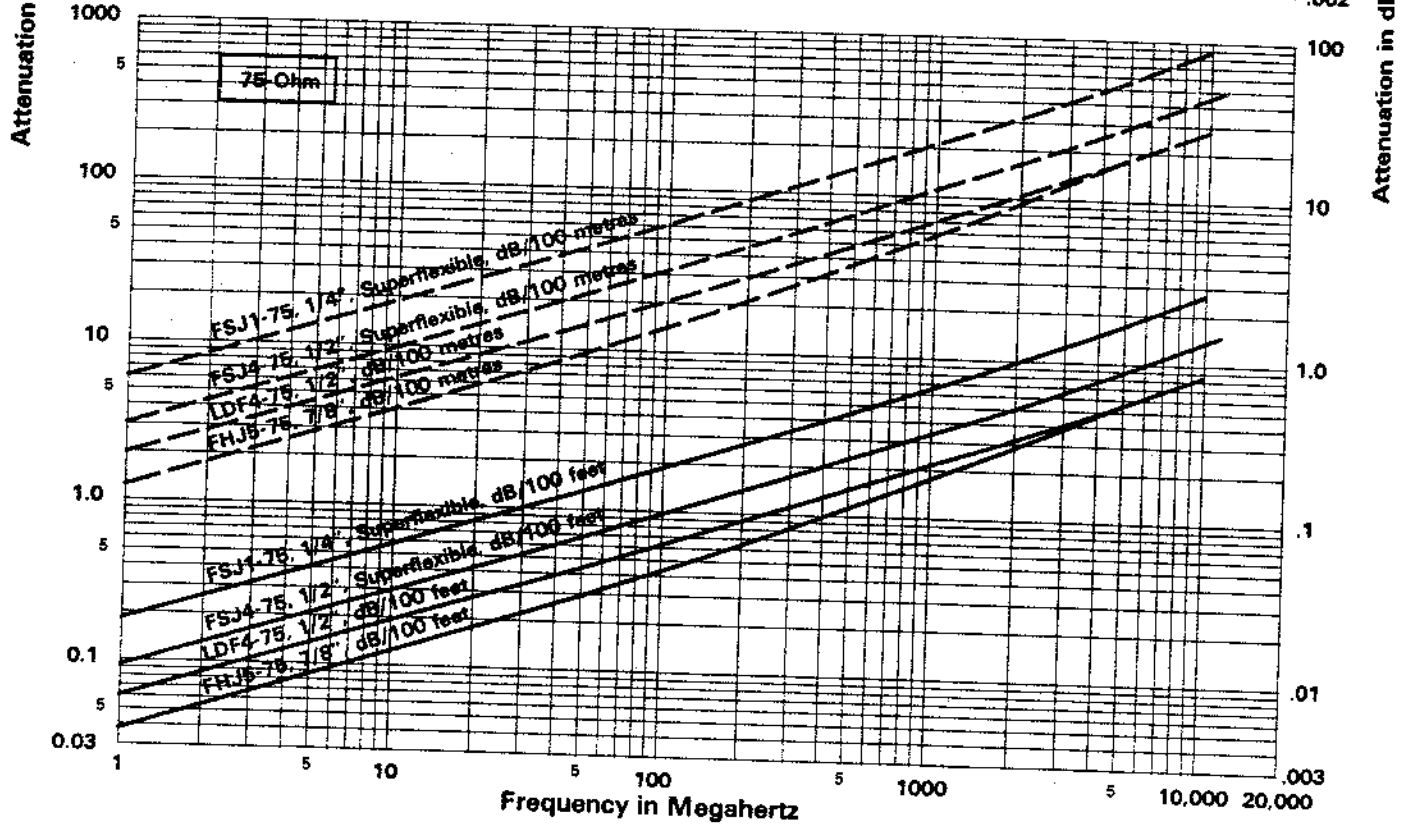
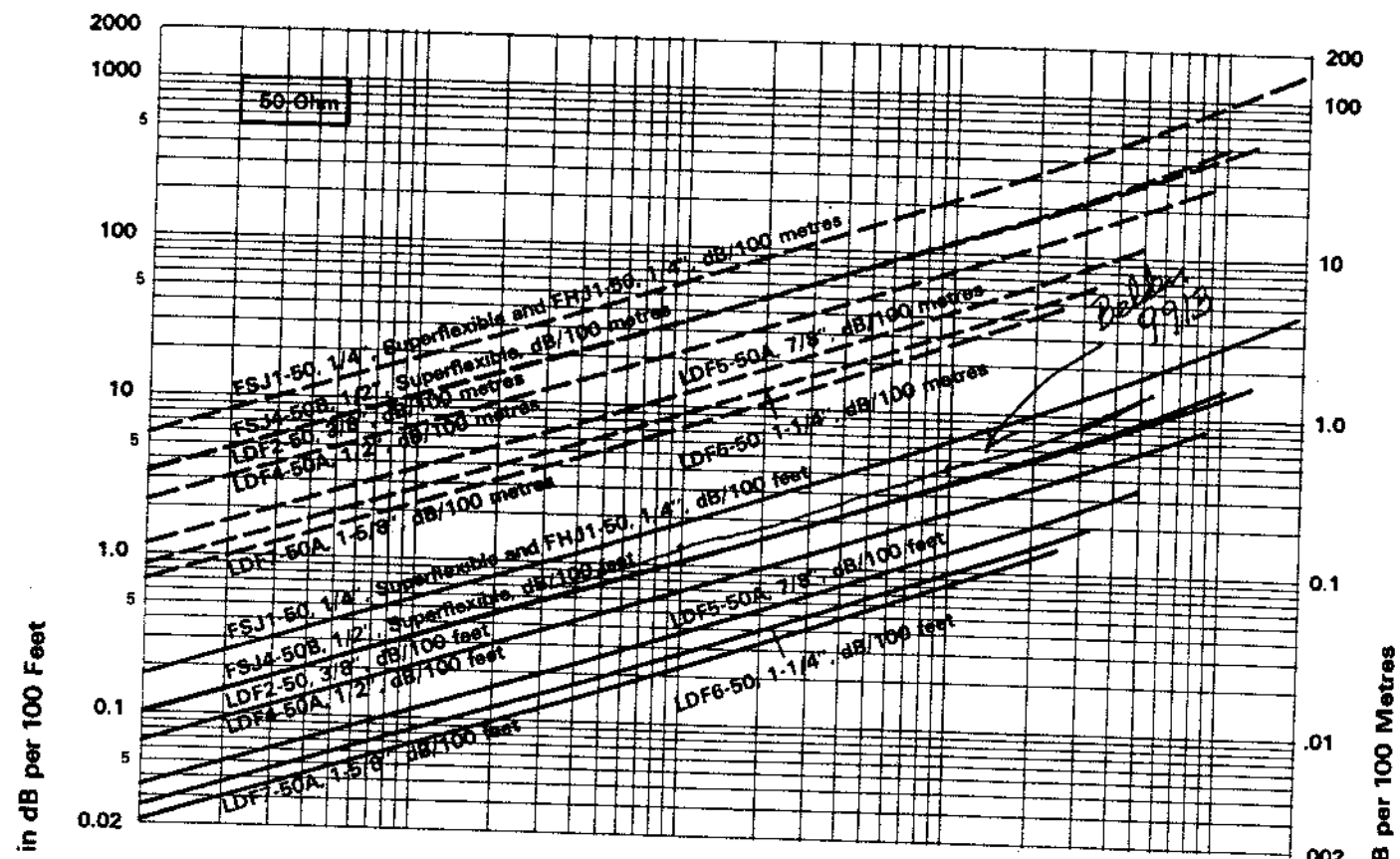

Attenuation Curves based on:  
 VSWR 1.0  
 Ambient Temperature 24°C (75°F)  
 Atmospheric Pressure, dry air

Conversion Data:  
 For other ambient temperatures, see curve on page 219.

# DOWN EAST MICROWAVE

MICROWAVE ANTENNAS AND COMPONENTS

BILL OLSON  
W3HQT

BOX 2310 RR1  
TROY, ME 04987  
(207) 948-3741

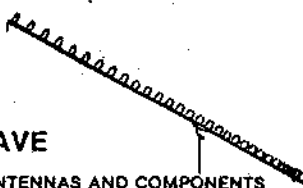

CRAIG HENDERSON  
N8DJB

Ph. (419) 352-4465  
Hrs. 10-5



C. A. T. S.  
Rotor Parts & Repair



7368 S.R. 105

Pemberville, OH 43450

215-288-0325



# W3HK

GEORGE S. VanDYKE, JR. P.E.

1737 Scattergood St.  
Phila., PA 19124

## The R.F. Connection "Specialists in RF Connectors and Coax"

**KA3QPG**

Joel Knoblock  
301/840-5477  
Fax 301/869-3680

Order Line 800-783-2666  
Suite 11, 213 N. Frederick Ave.  
Gaithersburg, MD 20877

(302) 328-7728  
ORDER LINE 800-441-7008



*Delaware Amateur Supply*  
"AMATEUR SALES AND SERVICE"

PAUL WA3QFX  
KATHY KA3IYO

71 MEADOW ROAD  
NEW CASTLE, DELAWARE 19720

(215) 898-5900 DAY  
(215) 343-2448 NIGHT

INDUSTRIAL  
COMMERCIAL  
RESIDENTIAL

**WARRINGTON ALARM CO.**  
LOCKSMITH • BURGLAR • FIRE

BOB HERSHMAN

417 DAVISVILLE ROAD  
WILLOW GROVE, PENNA. 19090-3483

215-342-5982

WA3HIT

Paul and Betty Rilling

INCOME DIVERSIFICATION

5830 Weymouth Street -Phila., Pa.19120

Gerry Rodski - K3MKZ

717-868-5643  
6-10 PM

SSB ELECTRONIC U.S.A.  
Call for Catalog

124 Cherrywood Dr. Mountaintop, Pa 18707

609-541-0120

**Bob Fischer Company, Inc.**

AERIAL LADDERS - UTILITY EQUIPMENT

BOB FISCHER  
PRES.

287K & LINCOLN AVE.  
CAMDEN, N. J. 08105

## ZD Engineering

Specialists in CATV Hardline  
Matching Transformers-Power Dividers  
and Related R.F. Devices

144 MHZ-1296 MHZ...

TO FIT 1/2, 3/4 AND 7/8 INCH HARDLINE.

PAUL H. DARWACTOR  
(419) 424-8785

W8ZD

605 Balsley Ave.  
Findlay, Ohio 45840

**DESTINATIONS INC.**  
A FULL SERVICE TRAVEL AGENCY

**HARRIET SOLTOFF**  
TRAVEL CONSULTANT

616 SOUTH THIRD STREET  
PHILADELPHIA, PA. 19147

RES. (215) 947-4483

MOVING - TRUCKS 7' x 7'  
SIL 8' x 4'

Day-Nite (215) 455-2121

## FERTIK'S ELECTRONICS . . . .

*Components & Equipment*

LEON FERTIK

5400 ELA STREET  
PHILADELPHIA, PA. 19120



RICHARD E. COMLY

TOOL, DIE & MACHINE CO., INC.  
2065 BENNETT RD. PHILA., PA 19116



(215) 676-1300  
FAX 934-5237

(809) 268-0738

RICHARD CONNOR



**RECON**  
*Communications*

- COMMUNICATIONS TOWER MAINTENANCE
- ANTENNAS, FEEDLINES, TOWERS INSTALLED
- TOWER PAINTING, RE-LAMPING, RE-GUYING
- RF SYSTEM TROUBLESHOOTING
- LIGHTNING PROTECTION, GROUND SYSTEMS

Emergency Service

412 Carranza Road  
Tabernacle, NJ 08086

(302) 328-7728  
ORDER LINE 800-441-7008



*Delaware Amateur Supply*  
"AMATEUR SALES AND SERVICE"

ROB WA3QLS  
GAL KA3ITN

71 MEADOW ROAD  
NEW CASTLE, DELAWARE 19720

(215) 745-6173  
(302) 886-7630  
(215) 342-8832



**COMPU-SIMPLE, INC.**  
COMPUTER APPLICATIONS FOR SMALL BUSINESS

ELLIOTT T. WEISMAN  
Consultant

P.O. BOX 7161  
WILMINGTON, DELAWARE 19803

## RUTLAND ARRAYS

For the finest VHF/UHF antennas  
1703 WARREN ST.  
NEW CUMBERLAND, PA 17070

Call or write for our new catalog!  
(717) 774-5298 7-10 pm EST

*Hopkins & Yampolsky, P.C.*

ATTORNEYS AND COUNSELLORS AT LAW  
1814 SPRUCE STREET  
PHILADELPHIA, PENNSYLVANIA 19103

STEVEN N. WHITE  
WA3IAO

TEL. (215) 545-1300

FIRST CLASS

PACK RATS



MT. AIRY  
VHF  
RADIO  
CLUB,  
INC.

MEETING  
NOTICE

DICK HUNTINGER  
W3FQD  
130 FAIRHILL RD.  
CHURCHVILLE, PA 18966

M 12/92

417 Carranza Rd  
Tabernacle, NJ  
08088  
Cheese Bits



ICOM

CHS

SEI

Miller

hy-gain

ASTATIC

Larsen Antennas

"W2AU"

HAM-KEY

Beacon

South River

ROHN

VIBROPLEX

NPC

TEN-TEC

TRW

TAB BOOKS

Sonar

Cushcraft

AMPHENOL

TELEX

SPRAGUE

Xcelite

Wilson Electronics Corp.

If we're  
judged by the  
company we  
keep, we should  
do pretty well!



"HAM" BUERGER, INC.

Electronic Equipment Distributor

"Right in the middle of a lot of good company!"

417 DAVISVILLE ROAD  
WILLOW GROVE, PA 19090  
215-659-5900

Service Since  
1956

GILFER  
LMB

TPL

callbook

Weller

waldom

communications specialists

BIRD

MISCO

Vector

HUSTLER

ME

phelps  
dodge  
Communications Company

SWAN

AMEGO

BOMAR

COVER CRAFT

AMP  
SPECIAL  
INDUSTRIES

BW

ICIR

ESG