

PACK RATS'



PACK RATS

CLUB CALL: W3CCX

MT. AIRY VHF RADIO CLUB, INC.

CHEESE BITS



MT. AIRY VHF RADIO CLUB, INC., PHILADELPHIA, PA.

50.125, 144.150, 220.125, 432.110, 1296.110 MHz, W3CCX - Repeater 222.98/224.58 MHz

Affiliated Club: AMERICAN RADIO RELAY LEAGUE

Meetings: Third Thursday of each month at 8:00 P.M.
Southampton Free Library, 947 E. Street Road
Southampton, Pennsylvania 19866

VOLUME XXV

DECEMBER, 1983

NUMBER 12

THE PREZ SEZ

Those of us who attended the November regular meeting really witnessed a treat. All of those autobiographies kept us spellbound. Thanks go to Ernie (W3KKN), Harry (W3CL) and Dave (WB2VLA) for coming up with a great idea for a program.

What an outstanding group of new members. It looks like they bring a wide range of experience to the Pack-Rats. I am confident that the club will benefit from their contribution in a variety of ways in years to come.

The Board of Directors welcomes all Club members to attend the Board meetings on the 2nd Thursday of each month. We are your elected officials. Why not come out and see how we conduct the official business of our Club.

Attendance to our regular meetings has been great! Let's continue to improve. It would be great to have 100% (or close to it) at our regular meeting in December. Mike, WB2RUX (with the able assistance of Harry, W3CL) has done an outstanding job getting the January contest shaped up. Mike tells me that the area captains are doing a great job also. Keep on pushing!

See you all at the December meeting.

73,

Bill, WA2DPU

Pack Rats CHEESE BITS is a publication of
THE MT. AIRY VHF RADIO CLUB, INC.
Philadelphia, Pa. and is published monthly.

SUBSCRIPTION RATE - \$2.50 PER YEAR

We operate on an exchange basis with other
publications. Anything that is printed in
CHEESE BITS may be reprinted, unless other-
wise stated, provided that proper credit
is given.

SWAP SHOP ITEMS - NO CHARGE

DEADLINE FOR ARTICLES IS THE GENERAL
MEMBERSHIP MEETING: THE THIRD THURSDAY
OF THE MONTH

EDITOR:

W3CL, HARRY B. STEIN
2087 Parkdale Avenue
Glenside, Pa. 19038
215-887-5052

PUBLISHER/SUBSCRIPTION MANAGER:

K3GAS, DOC CUTLER
7815 New Second Street
Elkins Park, Pa. 19117
215-635-1078

PRINTER:

WB2VLA, DAVID POWER
609-882-1040

TYPIST:

WA3TEM, MARSHA LISSAUER

TRUSTEE OF CLUB CALL W3CCX

WA3AXV, RONALD WHITSEL
215-355-5730

AWARDS CHAIRMAN:

W2EIF, JOSEPH KILGORE
609-783-9478

CLUB HISTORIAN:

W3CL, HARRY B. STEIN

MONDAY NIGHT NETS NET CONTROL

7:30 PM - 50.125 MHZ	W3CL
8:00 PM - 144.150 MHZ	W2EIF
8:30 PM - 222.98/224.58	K3GAS
9:00 PM - 432.1 MHZ	K3IUV-WA2DPU
9:30 PM - 1296.025 MHZ	W3CXU

PACK RAT REPEATER 222.98/224.58 MHZ
LOCATED IN CHURCHVILLE, PA.

OFFICERS: 1982-1983

PRESIDENT: K3KTY, JOHN TATE
VICE-PRES: WA2DPU, BILL SMITH
COR. SECY: W3ZD, DAVE ZIMMERMAN
REC. SECY: W3NSI, LYN ROWLAND
TREASURER: K3GAS, DOC CUTLER
DIRECTORS: W3ILT, HARRY BROWN
WB2RVX, MIKE GALLO (2 yrs)
WB2VLA, DAVE POWER (2 yrs)
WA3JUF, DAVE MASGARO (1 yr)
WA3NUF, PHIL MCGUEEN (1 yr)

FREE ESTIMATES
(215) 672-3850
(215) 822-0808



MICHAEL McMACKIN

REGISTERED PLUMBING & HEATING
BATHROOM INSTALLATIONS • ELECTRIC DRAIN CLEANING

96 HELLBERG AVE.
CHALFONT, PA. 18914

2405 PARKSIDE AVE.
HATBORO, PA. 19040

1-302-478-2757

AMATEUR
and
ADVANCED
COMMUNICATIONS



G. B. WALLS

3208 CONCORD PIKE (RT. 202)
WILMINGTON, DEL. 19803



**Pennsylvania Institute
of Technology**

PAUL D. MERCADO

Chairperson, Drafting Design Department

(215) 352-7100
(215) 528-6998

414 SANSOM STREET
UPPER DARBY, PA. 19082

Amateur Radio Equipment
Sales & Service

(609) 386-2348

D.P.U. ENTERPRISES

Antennas • VHF Amplifiers • Accessories

KLM

MIRAGE

Bill Smith
WA2DPU

47 Langdon Road
Burlington, NJ 08016

CALENDAR OF COMING EVENTS
Syllabus by Lee, K3MXM

DECEMBER

- 1 Hanukah
- 2 Model "A" Ford introduced and cost \$385 - 1927
- 7 The Day That Will Live In Infamy
- 8 Board of Directors Meeting - QTH: K3MXM, Lee Cohen, 8242 Brookside Road, Elkins Park, Pa. 19117. Phone: 215-635-4942 Directors and interested parties always welcome.
- 10-11 ARRL 10 Meter Contest - See Pg. 105, Nov. QST
- 11 ARRL 50 Mhz Sprint - 7 P.M. to 11 P.M. local time
- 15 General Club Meeting - Southampton Free Library. Final preparations for the Contest. Come out and get your 1983 certificate. The Mario Raffle, Frankie's Silent Auction, Refreshments.
- 15 Sitting Bull killed during arrest 1890
- 22 First Day of Winter - Antenna Tending Time....
- 25 A Merry Christmas to One and All....
- 30 4th Annual Winter SMIRK Contest 83/84 Winter Smirk Contest
- 31 HAPPY NEW YEAR!!

DO YOU HAVE JANUARY VHF SS QUESTIONNAIRE FILLED OUT AND BACK TO YOUR CAPTAIN.
CONTEST - JANUARY 14, 15, 1984!!!

* * *

* * * I told my wife. "A man is like wine. He gets better with age." So she locked me in the cellar....

SOME MORE MURPHY LAWS

No matter what you eat for lunch, your wife will serve it for dinner.
When in doubt call a meeting. When in trouble, form a committee.
Never argue with your boss unless you're willing to face the consequences of winning the argument.
If it's on sale, they don't have your size.
Never trust a dentist who has false teeth.
If you like it, you can't afford it.
The weather forecasters accuracy is directly related to whether or not his office has a window.
Nothing goes on sale until the day after you bought it.
Build a better mousetrap and someone will breed a better mouse...
The major side effect of medical treatment today is bankruptcy.
The average time between throwing something out and needing it is two weeks.

MOST PROFOUND THOUGHT: You cannot buy beer, you only rent it... Archie Bunker

NEW PRODUCTS OF INTEREST TO HAMS

By Lyn, W3NSI

1. SSB/CW 2 AND 6 M MINI-TRANSCEIVER KITS: ACE Communications, Inc. is advertising a pair of VHF QRP rigs available as Semi-kits in knock-down form for easy assembly. The MX6Z and MX2 cover 50 KHz on each of two channels available on these tiny VXO controlled radios. Output is .2-.25 watt from the transmitter section. The receiver is a single conversion unit using a crystal filter at 7.8 MHz. Either set is about the size of a pack of king size cigarettes. Power is supplied by 6 AAA cells or a 9 volt battery. It is necessary to solder a few wires to switches and connectors and mount the sub-assemblies into the case. Price \$130. 2832 D. Walnut Avenue, Tustin, California 92680

2. TRANSMITTING POWER AMPLIFIER FOR 1296 MHZ: The VHF Shop in Mountaintop, Pa. is selling two types of 1296 tube type amps. The single tube version uses a 7289 tube and is rated at 60 watts out with 10 watts drive. The two tube unit is rated at 120 watts with 10 watts input. Both are supplied and priced less tubes and blower. P.S. voltage rated at 1000. Price 60w \$219, 120w \$302. Box 349, R.D. 4, Mountaintop, Pa. 18707

3. ACTIVE INDOOR ANTENNAS: The Electronics Overseas Corp. is selling three versions of a broadband (3-30Mhz) antenna and booster to be used for short wave listening in the HF range. Gain is rated at 14-20 DB. All units use a built in whip of either 47" or 63" length. The HFA 001 has a built in power supply operating from 110 Vac. The HFA 002 has an external transformer and can operate from 110 or 220 Vac lines. The HFA 003 uses a 9 V battery supply. Prices \$24/35/26. 170 Cedar Ave., Hawthorne, N.J. 07506 (no charge for shipping)

* * *

UHF/VHF REPORT

By Joe, W2EIF

Not much to report for this period. It seems that the bands have quickly reverted to the precontest quiet conditions.

I am indebted to Ernie, W3KKN for a report of aurora on the weekend of Feb. 4,5,6 1983. He reports that the AU from his location was very good thru 220 MHz with excellent activity particularly on 2 meters. The AU extended South to the Virginia Beach area and Ky. He was able to work N4AR in Ky. with very good signals. There were lots of mid-West stations on, and the VE3 area was particularly active. No Es was reported, such as usually follows aurora openings.

The new Packrat 220.125 MHz net at 8:45 PM on Monday nites is picking up. There were 10 in the net on Monday February 14 - In honor of St. Valentine no doubt!

NOTE: There was a good opening on 432 Mhz over the Feb. 19/20 week-end. Contacts were made as far as Kentucky from this area - W3KKN, W3HFY and WA2DPU report. W2AXU reports AU opening.

* * *

ANNOUNCEMENT

4th Annual Spring VHF/UHF QSO PARTY - 1983: Spring VHF/UHF QSO Party - Sponsored by the Ramapo Mountain ARC. This year the rules for the VHF/UHF contest are similar to last year's rules and current ARRL UHF contest rules. Please note that the band multipliers award higher scores based on band popularity (144-50-432-220-1296 and up). This change is based on comments received last year. The grid square and range scoring system has been retained based on proven results obtained from the 1982 ARRL UHF Contest. Range scoring is the equalizer!

S.A.S.E. to RMARC for log/entry forms. All who submit the required data will receive a copy of our newsletter with results. Mail forms to Ramapo Mountain ARC, P.O. Box 364, Oakland, NJ 07436 no later than May 1, 1983. Date and Time: From 2100 hours UTC, Sat. March 26, until 0400 hours UTC, Monday, March 28, 1983.

SWAP SHOP

FOR SALE: LM-8 freq. meter and xtal calibrator w/pwr sply & manual \$25. TR-22 2 mtr xcvr plus 25W amp & 2 pwr splys, Xmtr needs work \$125. Philco camera & control box, cable & manual. Jeep TV box \$50. Auto antennas, tape recorder mikes, reel to reel tapes, A.C. Adaptors, tubes, resistors, electrolytic caps, variable caps - all sizes.

CONTACT: Doc, K3GAS
Phone: 215-635-1078

FOR SALE: Kenwood TS-600 6 mtr all mode xcvr plus AC sply in original box \$400

CONTACT: Bruce Loss, WA3YUE
Phone: 215-947-4166 (Home)
215-542-2966 (Work)

FOR SALE: AEA model CP-1 computer patch, works with any computer. Brand new (Hamfest Prize) \$149.

CONTACT: Ron Whitsel, WA3AXV
Phone: 215-355-5730

FOR SALE: 28 ASR Teletype 60 & 75 WPM gears \$100; XITEX video terminal w/keyboard, rack mtd. \$100; 2 mtr KW w/2-4CX250 tubes, partially completed \$100.

CONTACT: Tom Krohn, K3IJ
558 Forrest Hill Drive
Hazleton, Pa. 18201
Phone: 717-443-8822

FOR SALE: Icom - 2 mtr FM xcvr (IC-255A) for mobile or fixed operation w/reg. mike & HM-8 tone encoder mike, manuals, mint condx. make offer. WANTED: Commodore 64 (later model) home computer w/manuals. Very good to excellent condx. also Commodore color monitor or compatible color monitor for Commodore 64 unit w/good resolution for rtty & keyboard cw work.

CONTACT: Bob Wilderman, K3SRO
19 Glen Road
Lansdale, Pa. 19446
Phone: 215-822-7474

FOR SALE OR SWAP: Collins KWM - 2 A w/noise blanker, pwr sply & crystal pack \$675. Yaesu FT-290R - 2 mtr all mode xcvr w/nicads and charger \$285. HAL rvd - 1005 - Rtty receive device \$80. WANTED: YG-455C (500 HZ)

Kenwood filter for TS 830S - (Have YG-455CN (250 HZ) filter) also Hasselblad 500 EL body.
CONTACT: Gus, K3GYS
Phone: 609-767-3628 after 5:30 P.M.

NEW HAMTRONICS CATALOG

Hamtronics, Inc. announces publication of their new 1984 mail order catalog crammed full of goodies for the VHF/UHF/OSCAR enthusiast and two-way radio shops.

The 36 page two-color catalog features many new products, including an expanded line of FM Repeaters and accessories such as power amplifiers, DTMF Tone Decoder/Controllers, and Autopatches. Also included are the popular lines of FM and AM Receivers, FM Transmitters, VHF and UHF Transmitting and Receiving Converters, Space Shuttle Receivers, 800 MHz Scanner Converters, Preamps, and other products Hamtronics has long been noted for.

For your free copy of this attractive new catalog, call 716-392-9430 or write to Hamtronics, Inc., 65F Moul Rd., Hilton N.Y. 14468 (For overseas mailing, please send \$2.00 or 4 IRC's.)

* * *

AN OPPORTUNITY

The position of TECHNICAL/INTERNATIONAL EDITOR requires excellent written and oral communications skills, as well as a General-class or higher ticket. Experience with micro-computers would be a help. Responsibilities include participating in manuscript review, organizing and implementing special projects, and supervising our staff of foreign correspondents. CONTACT: Jack Burnett, Executive Editor, 73: Amateur Radio's Technical Journal.

RADIO SPORT 83
SPONSORED BY THE STATE LINE RADIO CLUB OF NY AND NJ
BY DAVE ZIMMERMAN, W3ZD

Some of us were treated to a very unique experience recently...a first time AMATEUR RADIO FLEA MARKET that was both a huge success and very well run. The State Line Radio Club and the director of promotion, Abel David, KX2F, are to be congratulated for doing a fine job.

Radio Sport 83 was held in Alpine, N.Y. which is just above the George Washington Bridge. One of the interesting aspects of the affair was the setting. The indoor portion was in the main lodge of a boy scout camp in the middle of a very delightful multi-acre woods. The tail-gaters were dispersed about the main lodge in wooded parking lot glens. Parking for buyers was ample, although not very close to the main areas, requiring a stroll of several hundred feet or more through winding roads in the forest. On such a fine spring-like day, not much wrong with that either.

Providing a fine touch was the free coffee and fresh bagels offered to each vender early in the morning, with a choice of butter or cream-cheese. Food was well-prepared and modest in price, with the feature: a copy of delicious home-made soup and crackers.

If held in the future, this event can only grow in size and popularity, and the only problem I see is out-growing the site.

* * *

VISITORS - MEETING NOVEMBER 17, 1983

KA2NYF, Janet - Deptford, N.J.
W3AJS, Ed - Oreland, Pa.
AA2Z, Mark - E. Hampton, Ct.

KA2JKI, John, Toms River, N.J.
WB2GEZ, Marty - Wrightstown, N.J.

CHANGE OF ADDRESS

WA3JUF, Dave Mascaro, XYL - Barbara
R.D. 1, Box 467
Ottsville, Pa. 18942
Phone: 215-675-2670 until
new number available

VOTED TO MEMBERSHIP

AA2Z - Mark J. Wilson; XYL - Jean
229 Marlborough Rd.
E. Hampton, CT. 06424
203-267-2179

KA2JKI - John C. Grove
917 Bay Ridge Avenue
Toms River, N.J. 08753
201-341-8390

WA2GEZ - Martin Hackett
R.D. #2, P.O. Box 56
Wrightstown, N.J. 08562
609-768-8865

* * *

TID BITS

Sunwatcher - Jack Power, W2AXU reports the monthly sunspot number for October, 1983 = 55.2 Smoothed number for April 1983 = 81.5

Our apologies to Mike, WB3LJK the caption on the photo page in the Nov. 1983 issue of Cheese-Bits listed his call alongside of W2EIF - the ham in the photo is W3ZZ. Blame the Editor PLEASE not our President!!

We hear that Steve Simons, KP6AJ is moving back East...Get your old call (WA3WAS) back Steve.

FROM THE BANGALORE AMATEUR RADIO CLUB
P.O. BOX 5053, Bangalore-560 001, India
AND
VISVESVARAYA INDUSTRIAL & TECHNOLOGICAL MUSEUM, BANGALORE-1.
Invite Hams Worldwide to participate in the
"GARDEN CITY CONTEST 1983"

We welcome Hams Worldwide to contact VU2s and VU2s are invited to contact other VU2s and Hams Worldwide.

CONTEST PERIOD: All contacts to be made between 1200 GMT Sat. the 17th of Dec., 1983 and 1200 GMT Sun. and 18th Dec. 1983.

MODE: CW only.

FREQUENCY BANDS: 40 & 20 Metre Bands. Contact with same station may be made once in each band.

ELIGIBILITY: Contest is open to all licensed Amateurs worldwide.

TYPE OF OPERATION: Single Operator.

CLASSES OF ENTRY: Group A for VU2s holding grade I license, Group B for VU2s holding grade II license. For Non VU2 Hams no group classification.

POWER & FREQUENCY BAND RESTRICTIONS: As per the stipulations in their license (restricted to 40 & 20 mtr. bands).

EXCHANGE: The exchange consists of complete RST report and the serial number of the Contact in three digits or more. Example (for the first contact) "VU2ARC UR RPRT 599001". Example for the 20th Contact "VU2HAM UR RPRT 599020" etc.

SCORING: Points earned by VU2s for making Complete Contact with

ASIA including India	1	Point
EUROPE, AFRICA & AUSTRALIA	2	Points
NORTH & SOUTH AMERICA	3	Points

DX stations score 1 point for every VU2 contacted.

ALL ENTRIES TO THE CONTEST MUST BE POST MARKED NOT LATER THAN 15TH JANUARY 1984 AND ADDRESSED TO:

The Convenor
Garden City Contest 1983
Bangalore Amateur Radio Club
P.O. Box 5053, Bangalore-560001
INDIA

* * *

NOTICE

Department of Communications
100 Wilson Boulevard
Eagleville, Pennsylvania 19403

The Montgomery County Communications Department has openings for:

1. A Second Deputy Director of Communications.
2. Two Senior Radio Technicians.

The Second Deputy Director job requires a person with extensive knowledge of Public Safety Telecommunications Systems and Operations. Should be well versed in electronics, electronic data processing and telephone systems.

The Senior Radio Technicians should have at least five years experience in F.M. two-way radio maintenance. Equivalent experience in related fields will be considered.

Interested parties should contact Tom Gibson at 631-5105.

A 28 MHZ DIPLEXER CIRCUIT FOR DOUBLE BALANCED MIXERS.

By Paul Drexler - WB3JYO

In order to obtain the rated performance of a double balanced mixer, the IF port must be properly terminated such that a purely resistive 50 ohm load is presented at both the IF and image frequencies. Failure to meet this requirement results in higher level Intermodulation Distortion (IMD) products and decreased dynamic range. This is discussed by Rohde in October 1975 Ham Radio.

A diplexer circuit with better than 20 db return loss is presented here. The diplexer consists of a lowpass filter and a highpass filter in parallel.

The diplexer circuit below:

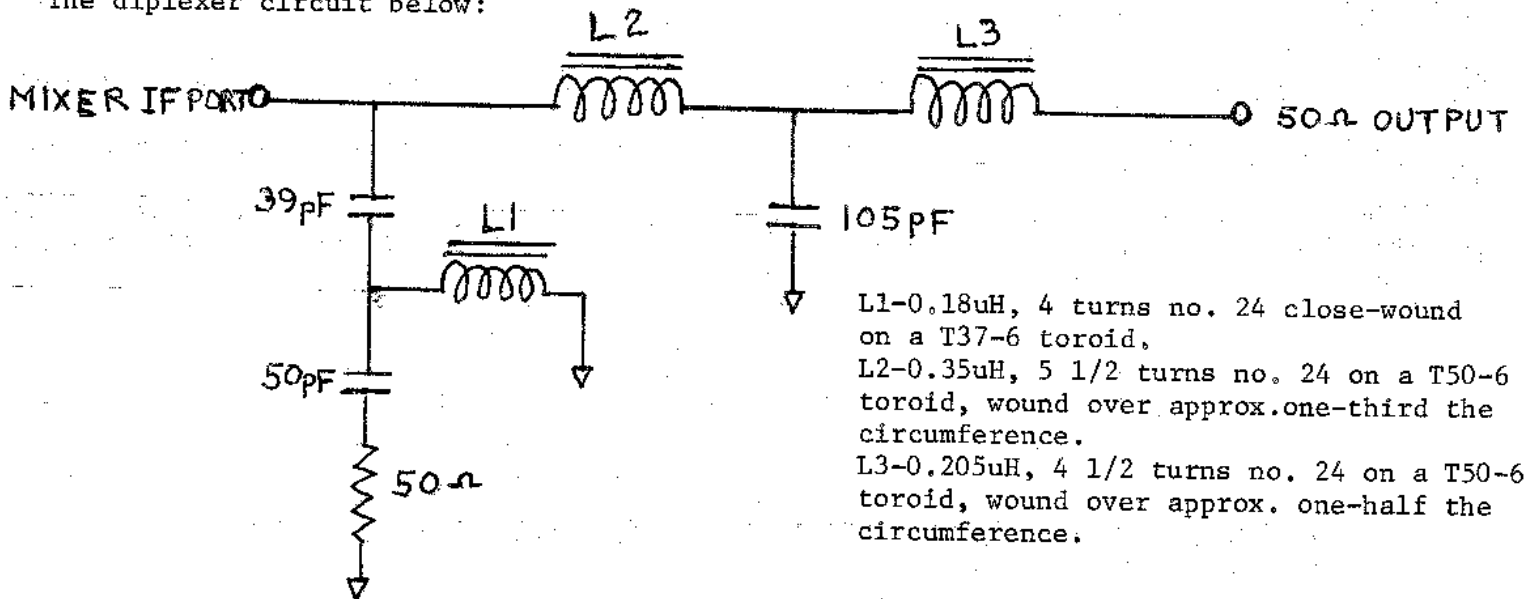

The diplexer was used to terminate a Mini-Circuits SRA-1H high level double balanced mixer. The mixer was fed with a +17 dbm L.O. at 116 MHz and an RF signal at 144 MHz. A hybrid combiner was used to feed the output of two generators used at the R.F. frequency to the mixer's R.F. port. An H.P. 8568A spectrum analyzer was used to measure signal levels. 6 db pads were used between the generators and the combiner. A variable step attenuator was used between the combiner and the mixer RF port. Using this test configuration, third order distortion was measured and a third order intercept of +19 dbm was calculated.

A better method of terminating balanced mixers must be found if their superior characteristics are to be utilized. The diplexer offers an alternative, however other methods require investigation. One such method which has not been investigated, is to use a Teledynamics CP643 power JFET as an IF amp. The JFET has a characteristic low input impedance, close to 50 ohms, and may provide superior termination over the use of a diplexer. Rohde uses this technique as well as Stroud in a 220 MHz transverter (August 1982 QST).

* * *

STOLEN EQUIPMENT ALERT

An ICOM 255A 2 meter radio was stolen on November 23, 1983 from the car of N4DRY, John McCormick of Lynchburg, Va. while visiting with his brother Willard of 4245 Lawndale St., Phila., Pa. Phone: 215-289-6534. Pass along information to Willard or the Phila. Police Dept. East Detectives, Front and West Moreland Sts., Phila., Pa.



THE DIRECTORS MEET IN TOMS RIVER - OCTOBER 15, 1983

Back row - KA2JKI, K3GAS, WB2VLA, W3CL, K3MXM, WB2RVX, WA3AXV
 Front row - WA2DPU - The Hosts KS2T and Mr. & Mrs. Miller
 W3NSI the rec.secy snapped the foto

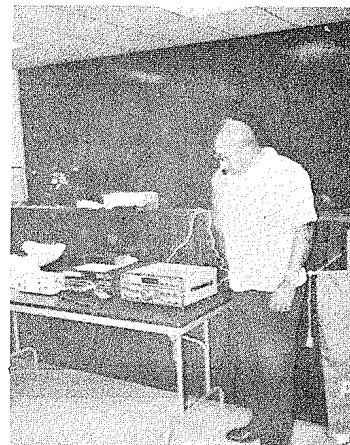
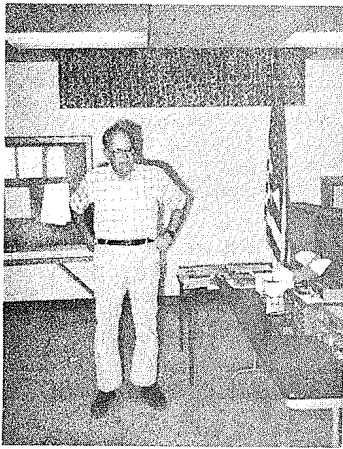

COMMENTATORS - W3NSI WA3AXV WA2DPU



PACK-RATS AND FRIENDS

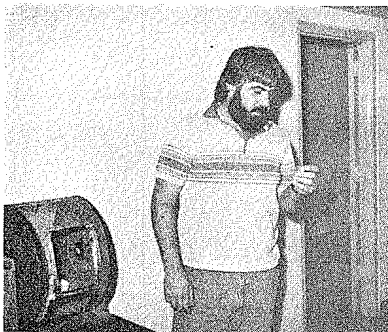

MARIOS RAFFLE WA3JUF



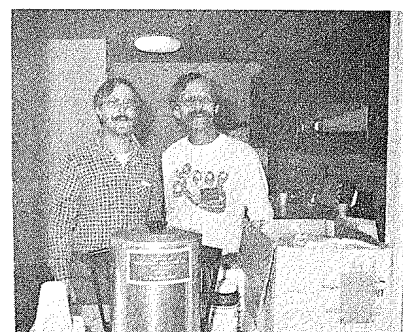

SO THATS WHAT IS NEW



REFRESHMENTS - WB2VLA W3IIT

NEW EQUIPMENT EXPOSE -- MEETING OCTOBER 20, 1983

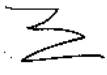
<p>HAPPY HOLIDAYS TO ALL THE PACK-RATS K3ILV - Bert and Family</p>	 <p>Ho! Ho! Hope your Holidays are filled with Joy! DAVE WBZVLA NANCY KZAJI NATHAN</p>	<p>Seasons Greetings JO + SUSIE WZEIF</p> 	<p>SEASONS GREETINGS DE ERNIE WSKKN & BERT W3TNP</p>	<p>HAPPY HOLIDAYS ED + MARY W3AJS W3CI</p>
<p>Happy Holidays DE W3FOF + Family Lynda, Dawn + Denise Much DX in New YEAR 73</p>	<p>Season's Greetings Mike W3ARVX  Janet K3RNYF </p>	<p>Greetings From The South Tom + Sally Matthews W4IJC (W3WID)</p>	<p>HAPPY HOLIDAYS THE CHANCELLOR OF THE EXCHEQUER GORDON K3UYG</p>	<p>SEASONS GREETINGS W3JUF DAVE BARB DAVE JR</p>
<p> SEASONS GREETINGS DOC & LORETTA CUTLER K3GAS</p>	<p>HOLIDAY GREETINGS FROM JACK W2AXU FLORENCE W2WYE </p>	<p>HAPPY CHANUKAH  MARSHA (W3TAA), FRED, JOSHUA & REBECCA</p>	<p>Happy HOLIDAYS JOHNNIE W3CYU TANNY + DOODLES</p>	<p>Seasons Greetings W3C1K Carol + PETE</p>
<p>HAPPY HOLIDAYS from The Pattisons Rich, Jorge + Kaye K3ACR</p>	<p>HAPPY HOLIDAYS FROM SYLVIA + HARRY W3CL</p>	<p>HOLIDAY GREETINGS SALLY & LYNN W3T61 SILVANCE & LYNN SR W3LHHT</p>	<p>Holiday Greetings de Peg + Lee K3MXM</p>	<p> Season's Greetings from Bill and Sandy W3HQT</p>
<p>Best Holiday Wishes From Joe + Mary Rushton W3YXF</p>	<p>GREETINGS FROM COLORADO. W3RSD</p>	<p>MERRI XMAS ES HAPPY NEW YEAR FM JANE W3BDSK "73" DAVE W3ZD MARK NANCIE JILL SCOTT</p>	<p>Seasons Greetings from Connecticut de Mark Wilson AA3Z</p>	<p>Seasons Greetings Harry W3IIT Rose Diane David Denise</p>
<p>HOLIDAY GREETINGS DE GRACIE - W3BBJQ ES GEORGE - W3HK</p>	<p>Seasons Greetings From John and Barbara K3KTY</p>	<p>HOLIDAY GREETINGS FM TOMS RIVER The Millers JAY K3ZT</p>	<p>Seasons Greetings from Helen Brick (Mother Rat) </p>	<p>MERRY CHRISTMAS! FROM GARY W3ZOMY</p>

215-947-8670

MARKETLINE™

SYSTEMS, INC.
2337 Philmont Avenue
Huntingdon Valley, Pa. 19006

Computers & Peripherals

KC7ZK CARL BARISH™

PRINTECH PRINTING
13620 NE 20th Suite D
Box 4247
Bellevue, WA 98009
746-6000

NE 7-6329

GEORGE S. VAN DYKE, JR., P.E.
CONSULTING ENGINEER

W3HK

4607 CONVENT LANE
PHILA., PA. 19114



AMIL S. GUMULA
PRESIDENT

A. G. RADIO PARTS CO.
939 TOWNSHIP LINE RD.
ELKINS PARK, PENNA. 19117
TELEPHONE: 215-669-9100

RCM Authorized
Distributor

K2RPZ PRINT

stu goodman

Distinctive QSLs-Largest selection, lowest prices, top quality photo and completely customized cards. Make your own QSLs truly unique at the same cost as a standard card, and get a better return rate! Free samples, catalogue. Stamps appreciated. Stu, K2RPZ, Box 412, Dept. PR, Rocky Point, NY 11778. (516) 744-6260

AMATEUR
SALES & SERVICE

(215) OL 9-5900

"HAM" BUERGER INC.
Communication Specialists

BOB HERSHMAN
WA3Z1D

68 N. YORK RD.
WILLOW GROVE, PA. 19080

P E N N A R C
A GENERAL PURPOSE CLUB

Monthly meetings the 4th Tuesday-8PM
Montgomery County Community College
340 DeKalb Pike, BlueBell, Pa.
CLUB REPEATER - 223.04/224.64 Mhz

The Ham Radio Publishing Group



Greenville, NH 03048 (603) 878-1441

HAM RADIO - the Technical Ham's
Magazine. Ask for a free sample
copy or our Book Catalog.

CALL DOC CUTLER (K3GAS)
FOR YOUR ELECTRONIC NEEDS

NEW, RECONDITIONED, OR AS IS.

LOW PRICES

by appointment 215-635-1078

Heathkit
ELECTRONIC CENTER

Stan Demski
Manager

Heathkit Electronic Center
6318 Roosevelt Blvd.
Philadelphia, Pennsylvania 19149
(215) 288-0180



**NESHAMINY
TRAVEL
SERVICE**

Harriet Soltoff
Home: (215) 947-4483

Phone:
(215) 757-1585

2337 Neshaminy Blvd.
Bensalem, PA 19020

BROWNS - THURS. 7:00-9:00
SAT. 8:00-6:00
Day-Nite (215) 455-2121

FERTIK'S ELECTRONICS

Components & Equipment

LEON FERTIK

5400 ELLA STREET
PHILADELPHIA, PA. 19120

LUNAR KLM ASTRON
MICROWAVE MODULES
TAMA

(717) 868-6565

THE
VHF SHOP

BOX 349 R.D. 4
MOUNTAINTOP, PA. 18707

K3MKZ
GERRY

215-PI5-9007

WA3FOF

RALPH ALEXANDER

Electronic Equipment Repair
Technical Writing

(215) 729-1200
(215) 646-2600



CARR ELECTRONICS
AMATEUR RADIO GEAR - NEW & USED FOR TODAY'S HAM

JOSEPH J. BURGESS
W3PNL

MAIN & RELIANCE
TELFORD, PA 18969

215-342-5982

WA3HIT

Paul and Betty Rilling
INCOME DIVERSIFICATION

5830 Weymouth Street -Phila., Pa.19120

73 magazine
for radio amateur

73 stresses the fun
of ham radio.

\$25 one year \$53 three years
POB 931 • Farmingdale NY • 11737



MASTER BLASTERS
Master Disc Jockeys
FOR A PARTY YOU'LL NEVER FORGET

BUZZ
(215) 722-5840

BRIAN
(215) 342-8832

