

PACK RATS'



PACK RATS

CLUB CALL: W3CCX

MT. AIRY VHF RADIO CLUB, INC.

CHEESE BITS



MT. AIRY VHF RADIO CLUB, "THE PACK RATS", PHILADELPHIA, PENNSYLVANIA
NET FREQUENCIES: 50.125, 144.150, 222.125, 224.58/222.98, 432.110, 903.100, 1296.100 MHz
AFFILIATED CLUB: AMERICAN RADIO RELAY LEAGUE

W3CCX
ARNS

Meetings: Third Thursday of each month at 8:00 PM
Southampton Free Library, 947 E. Street Road
Southampton, Pennsylvania 19866

SCANNED TO PDF BY BERT, K3IUV, 2013

VOLUME XXXIV

FEBRUARY 1992

NUMBER 2

THE PREZ SEZ

The January contest is now history along with the flurry of activity that led up to it. The best part of the contest for me is getting ready for it. This year, many club members became involved in helping others in the club with rig, antenna, and tower repairs. The hurricane force winds which occurred a week or so prior to the contest struck fear into most area VHFers. It seems like it's been unusually windy since the first of the year. To the best of my knowledge only K3LOM had major tower damage from the last big blow.

Activity on the club repeater increased in the weeks prior to the contest as equipment for 5760 was completed, tweaked, and put on the air. Others tested and re-tested in preparation for the big day. I decided that it was time to put my 5760 station on the air. My one hopeful contact, N2CEI, had dish antenna problems so I missed having an initial QSO on the band. I am on the band though and ready for the next attempt! Also, I connected my 10 GHz equipment (which has been laying around here for a couple of years) only to find that it has some receive problems... no QSO's on that band either.

This leads me to my tip to all of you. Now that the contest is over, make a list of what went well and what did not go as planned. Over the next year, make improvements to your station. Ask for help if you are having difficulties. Check on other Pack Rats who were not on the air during the contest to see if they can become active with your help. The January contest can be fun, but the real fun is working with each other to improve our stations. Hopefully your improvements will yield new grids or increased contacts. Don't wait until next contest; get on the air as time permits and enjoy the fruits of your labor.

I have not mentioned how the club did in the VHF SS, because at this writing I don't know. But, I want to thank each and every one of you that participated. For those club members that were not active or ineligible, let's begin preparation for 1993. A good way might be to attend the annual "Crying Towel" meeting. See all of you there.

73, William T. Murphy W0RSJ
FN20JR

Pack Rats CHEESE BITS is a publication of the Mt. AIRY VHF RADIO CLUB, INC. Philadelphia, Pa. and is published monthly. SUBSCRIPTION RATE - \$10.00 PER YEAR

We operate on an exchange basis with other publications. Anything that is printed in CHEESE BITS may be reprinted, unless otherwise stated, provided proper credit is given.

DEADLINE FOR ARTICLES AND SWAP SHOP IS THE 20TH DAY OF THE MONTH. NON-COMMERCIAL SWAP SHOP ITEMS - FREE OF CHARGE.

SUBSCRIPTION/ADVERTISING MANAGER:

WB2YEH, BOB FISCHER
7258 WALNUT AVENUE
PENNSAUKEN, NJ 08110
(609) 665-8488

EDITOR:

WC2K, RICK CONNOR
412 CARRANZA ROAD
TABERNACLE, NJ 08088
(609) 268-0736

CONTRIBUTING EDITORS:

W3IIT, HARRY BROWN WB3JYO, PAUL DREXLER
3012 POTSHOP ROAD 24 MAIN BLVD
NORRISTOWN, PA 19403 TRENTON, NJ 08618
(215) 584-4846 (609) 538-1687

TYPIST/PRODUCTION ASSISTANT:

JANICE CONNOR

AWARDS CHAIRMAN:

W2EIF, JOE KILGORE
(609) 783-9478

CLUB HISTORIAN:

W3CL, HARRY B. STEIN
(215) 887-5052

TRUSTEE OF CLUB CALLSIGN - W3CCX

WA3AXV, RON WHITSEL
(215) 355-5730

PACK RAT 220 FM REPEATER - W3CCX/RPTR
222.98/224.58 MHz, CHURCHVILLE, PA

OFFICERS: 1991 - 1992

PRESIDENT: W0RSJ BILL MURPHY
VICE-PRES: WB2YEH BOB FISCHER
REC. SECY: WA3AQA WALT ZUMBACH
TREASURER: WA3JUF DAVE MASCARO
COR. SECY: WB3JYO PAUL DREXLER
DIRECTORS: WA3AXV RON WHITSEL (1 YR)
 K3EOD AL BOBLITT (1 YR)
 N3AOG DICK COMLY (2 YRS)
 WA3NUF PHIL MIGUELEZ (2 YRS)

MONDAY NIGHT NETS
7:30 PM - 50.125
8:00 PM - 144.150
8:30 PM - 222.125
8:30 PM - 224.58/R
9:00 PM - 432.110
9:30 PM - 1296.100
10:00 PM - 903.100

NET CONTROL
W3CL + K3EOD
W2EIF
WC2K
K3ACR
WA3AXV
WA3NUF
N3AOG

VHF CONFERENCE CHAIRMAN:

KB3XG, JOHN SORTOR
(215) 766-2643

HAMARAMA CHAIRMAN:

K3EOD, AL BOBLITT
(215) 742-3312



THE AMERICAN RADIO RELAY LEAGUE

QST

HUGH A. TURNBULL, W3ABC
Director, Atlantic Division

6903 RHODE ISLAND AVE
COLLEGE PARK, MD. 20740

(301) 927-1797

1-302-478-2757

"Gisele"

**AMATEUR
and
ADVANCED
COMMUNICATIONS**

K3WAJ

G. B. WALLS

3208 CONCORD PIKE (RT. 202)
WILMINGTON, DEL. 19803

Graphic Design

Illustration

Production



Lynne D. Whitsel

209 Frog Hollow Road
Churchville, PA 18966
215 355-5730

CALENDAR OF COMING EVENTS

By Harry Brown, W3IIT

FEBRUARY

- 8 January Contest wrap-up session at the QTH of Bob, WB2YEH, starting at 10:00 AM. Get your logs and checksheets to your contest team captain so they can be checked and submitted.
- 9 Birth of Brendan Behan, Dublin 1923
- 9 LIMARC Hamfest at Electronics Hall, 41 Pineland Rd., Melville, NY. Talk-in on 146.25/.85 rpt. r.
- 12 Lincoln's Birthday
- 13 Rack Rat board of directors meeting at QTH to be announced. Listen for location on club nets or at the wrap-up meeting.
- 13 LIMARC Hamfest at Electricians Hall, 41 Pineland Rd., Melville, NY. Talk-in: 146.25/.85.
- 14 St. Valentine's Day. Remember your sweetie!
- 15-16 ARRL International DX Contest - CW. See Dec QST page 98 for rules.
- 17 Washington's Birthday (Presidents' Day observed)
- 20 Rack Rat general membership meeting at the Southampton Free Library on Street Road in Southampton, Pa. The theme of the evening will be our annual "Crying Towel" session. The best story of what went wrong during or in preparation for the January VHF Sweepstakes wins the coveted "Crying Towel". All members, friends, and interested parties are welcome to come enjoy the evening with us.
- 29 Annual AARG Hamfest and Computer Show at the Lebanon Fairgrounds in Lebanon, Pa. Talk-in: 146.04/.64

MARCH

- 1 York Ham and Computer Springfest at the Dover Firehall, Dover, Pa. VE exams will be given. Talk-in: 146.37/.97
- 20 Rack Rat annual "Homebrew Night"

VOTED TO MEMBERSHIP

JIM ALEXANDER, N2MVP
Box 1154
Bedminster, NJ 07921

APPLICATIONS FOR MEMBERSHIP

MIKE ANDRAYO, N2DEQ RUSS HUNT, WQ3X
RONALD CLUCK, N2NVT

903 NET NEWS

Activity has been steady over the last 6 months or so. Have had an average of 5 souls check in each Monday night. This might not sound like an outstanding number but it's never the same guys checking in. If everyone would be a "regular", I would have 10 or 12 per night! I realize the late hour (10 PM), but we sure would like to hear your call on the Pack Rats's newest net, 903.1. Remember, the other stations are evaluating their receivers and antennas by how well they can copy. Listen for Paul, WA3NZL in FM19. He's a regular check-in. Stations logged on the net in the past are: WC2K, WB3DNI, WA3AXV, W2EIF, N2SB, WA3NUF, AK3O, WA3JUF, WB2YEH, N2LIV, KB3NQ, K3ESJ, W3GXB, WA2ONK, KT2B, N3CX, WA3NZL, K3HZO, N2GHR, N4HB, and W3HFY. Thanks to all for your participation. DE N3AOG.

222 NET NEWS

Activity on the 222.125 MHz net has been consistent with 10 to 15 check-ins per night. Total initial check-ins is now at 106, with 4 new stations on the band and active on Monday night since January 1. I am looking for club member(s) to assume the net control responsibility for this net by March 30, 1992. The net has been built to a level of reliability, fun, and organization which will be easy to maintain by any member sufficiently equipped. If you run 100+ watts and a single antenna of good design and moderate height, you are sufficiently equipped. My personal time for activities outside of family and work is depleted. I regret to have to turn the mic over to someone else because I really love the 'ole 220 net. However, it's time to let someone else enjoy that weekly pleasure and I encourage any and all of the Pack Rats to take over. Here's a great way to serve your club in a big way from the comforts of your home shack. Interested NCS candidates should contact the Board of Directors or me immediately... March 30 will be my final net night as NCS. DE WC2K

TID BITS

We regret to report that two Pack Rat members lost loved-ones recently. Elliot's (K3JJZ) mother passed away on January 31, 1992. Tony's (W3HMU) mother-in-law passed away recently and was buried on January 15, 1992. The Mt. Airy VHF Radio Club extends it's deepest sympathy to the families of these two members.

John Allen, W3CXU has been under the weather lately. Hope that you're feeling well real soon, Johnny.

Dave, N3CX built the WB3JYO 6-meter transverter and it works great. The transmitter is very linear and the receiver section held up great to the January contest. Contact Dave or Paul if you have any questions concerning the construction of the modules. It's a great winter project.

JUNE CONTEST UPDATE

The first meeting for the upcoming June outing will be held at the QTH of chairman Dave Hackford, N3CX on Sunday February 23, 1992. Lunch will be served at 1:00 PM and I hope you like chili. Please let me know if you're coming so we can plan for the meal. We have a lot to discuss! All members who are planning to participate in June should be present at this meeting. Project construction dates will be set up and mum's the word on the restructuring. 73 and CU on the 23rd of February. DE N3CX

SWAP SHOP

FOR SALE: AM6154 432 MHz linear amplifier. Uses 8930 final tube. 120/240 VAC power supply. 10 watts input - 300+ watts output. Converted for 432 operation by N3CX. Complete and in excellent operating condx. \$400. Another AM6154, converted for 432 MHz, less tube, \$250.

CONTACT: David Hackford, N3CX Tel: 215-679-7293 (h) 215-483-2030 (w)

WANTED: Long-boom, high-gain, 223 MHz yagi. To improve my sig in/out of W3CCX/R.

CONTACT: Dave Martin, WB8ZAR Tel: 717-366-2220

FOR SALE: TOWER, 70ft crank-up. Tri-Ex HS-471. 4 sections, 440 lbs, 22ft nested requires guys. Tower is down and ready to haul. \$300.

CONTACT: John Sortor, KB3XG
215-766-2643

FOR SALE: Cushman CE-2 communications analyzer, \$200. 384 MHz L.O., \$20.

CONTACT: Chuck Grabowski, WA2ONK
609-586-7180 after 5 PM

WANTED: 432 MHz RF amplifier, 500+ watts. Also need 4-way power divider, etc.

CONTACT: Woody Peitzer, AK2F, 10 Berry Lane, Randolph, NJ 07869
(201) 584-5709 (after 6:30 PM)

FOR SALE: W3CCX RIW-19 432 yagis, \$25 ea. W3CCX 903 loop yagis. \$25 ea.

These antennas are proven winners and in excellent shape.

CONTACT: David Hackford, N3CX

WANTED: Icom IC-290A or other 10-25 watt 2M multimode.

CONTACT: Harry Price, K3HZO 531 Carla Dr., Huntingtown, Md. 20639

FOR SALE: 20-meter linear amp, (4) 6LQ6's, 600W output w/pwr supply, \$50.

Heath SB-200 linear amp, immaculate condx, 1200W input, w/new Cotron 572B tubes, AG6K parasitic suppressors, \$375.

CONTACT: Fred Munzenmayer, KB2BF 609-228-4580 (h) 783-4808 (w)

JOB WANTED: Position as electronics technician. Design and test experience in high power, high frequency, solid state RF. AAS in Electronics Engineering Technology. Four years experience in electronic troubleshooting. Will supply complete resume. References available.

CONTACT: Thomas Collins, KY2T 609-298-0019

COMMERCIAL AD

LOOP YAGIS: 902 MHz 33 element \$89 kit, \$109 assembled and tested. 1296 MHz 45 element \$89 kit, \$109 assembled and tested. 1296 MHz 55 element "Super Looper" \$99 kit, \$124 assembled and tested. 2304 MHz 45 element \$75 kit, \$89 assembled and tested. Also available: element and hardware kits for above. 2 and 4-way power dividers. Discount on complete arrays. Solid state linear power amps, 13 VDC: 1296 - 8W in 35W out \$315, 1W in 20W out \$265, 4W in 70W out \$695. GaAs FET preamps: 902 MHz .8dB NF \$90, 1296 MHz .8dB \$90, 2304 MHz 1 dB max NF \$140. SHF SYSTEMS no-tune transverter kits, w/144 MHz IF now available for 903 through 3456 MHz. Write or call for complete catalog. DOWN EAST MICROWAVE, Bill Olson, W3HQT, Box 2301 RR-1, Troy, Maine 04907. For information and orders telephone (207) 948-3741.

ATLANTIC DIVISION AWARDS

The Atlantic Division Convention, held in conjunction with the Rochester, NY Hamfest, May 15-17, will once again honor the finest Amateurs in our Division. "Amateur of the Year" recognizes the all-round outstanding ham. "Grand Ole Ham" honors lifetime achievement and is open to all hams that are at least 50 years of age or licensed at least 30 years. "Technical Achievement" may be presented to an individual or group. Complete information on nominations has been sent to all ARRL affiliated clubs. Nominations deadline is April 1, 1992. It's a great way to say "thank you" to the people who make you proud to be a ham... isn't there someone you know who deserves this recognition? I can think of several Pack Rats who do. As a club, let's nominate our finest for deserved recognition.

FOUNDATION SCHOLARSHIPS

The Foundation for Amateur Radio Inc., a non-profit organization with headquarters in Washington, DC, plans to administer 45 scholarships for the academic year 1992 - 1993 to assist licensed Radio Amateurs. The Foundation, composed of fifty local area Amateur Radio Clubs, fully funds five of these scholarships with the income from grants and its annual Hamfest. The remaining forty are administered by the Foundation without cost to various donors.

Licensed Radio Amateurs may compete for these awards if they plan to pursue a full-time course of studies beyond high school and are enrolled in or have been accepted for enrollment at an accredited university, college or technical school. The awards range from enrollment at an accredited university, college, or technical school. The awards range from \$500 to \$2000 with preference given in some cases to residents of specified geographical areas or the pursuit of certain study programs. Clubs are encouraged to announce these opportunities at their meetings, on their nets, during training classes, and in their club newsletters.

Additional information and an application form can be requested by letter or QSL card, postmarked prior to May 31, 1992 from: FAR Scholarships, 6903 Rhode Island Ave., College Park, MD 20740. The FAR is an exempt organization under Section 501(c)(3) of the Internal Revenue Code of 1954. It is devoted exclusively to promoting the interests of Amateur Radio and those scientific, literary, and educational pursuits that advance the purpose of the Amateur Radio Service.

Filter Designators

Most electronic literature is now using the filter symbols, but I've never seen any official information for the different types. DE WA5VJB

Passes:



Low Pass

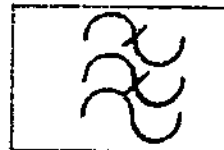

Attenuates:



High Pass

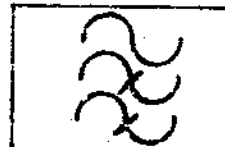

Band Pass



Notch

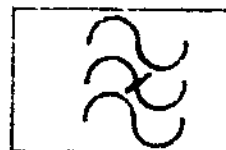

TNX NTMS "FEEDPOINT"

Microwave Frequency Standard - KOKE

Keith R. Ericson 11090 N. Forest Hills Dr. Parker, CO. 80134

This is a brief description of a system I put together that gives very precise microwave frequencies that can be used for band edge markers or a foundation for a beacon. Frequency West phase locked multipliers are used for 1296, 2304, 3456, 5760, and 10368 MHz as reference signals around the hamshack. A crystal can be placed in each unit's oven at 96 or 108 MHz and gives good stability (parts in 10 to the 7th) on the order of plus or minus several KHz. The next step was to place the multiplier inside a 2 lb. coffer can which improved things severalfold by helping to maintain a more constant oven temperature. I was still not satisfied! The quest for the ultimate was still on.

I have an HP107A timebase for the 5245L counter that allows me to count with an accuracy and stability of parts in 10 to the 10th (that's Hertz at 10 GHz). I wanted the same order of stability out of the Frequency West units which could only be obtained by a high stability 96 MHz signal which could be injected into the unit via the crystal socket. The basis for this 96 MHz signal was derived from the 1 MHz standard internal to the HP5110 synthesizer driver. Internally, the synthesizer driver has a high stability ovenized oscillator (10 to the 9th) that feeds a SRD multiplier through extensive filtering and amplification to give clean outputs at 1 MHz intervals from 30 to 40 MHz. These are then sent to a HB tripler that takes 32 MHz to 96 MHz or 36 MHz to 108 MHz. The Frequency West multiplier does the rest.

This system could be adapted for LO use or used at lower frequencies such as 144 or 432 MHz. There is something comforting (Though hardly necessary) about knowing where 10368.000,000 MHz is on your dial traceable to NIST via WWVB on 60 KHz.

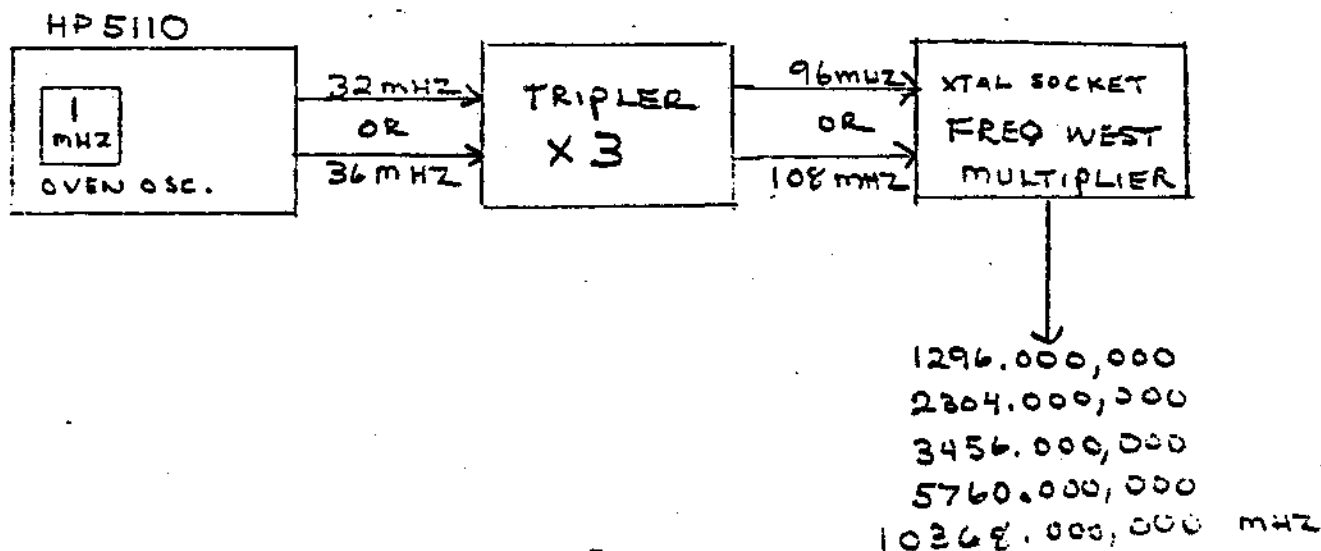

New Twist in Microwave Transverters

Dec 5th. 1991 WA5VJB worked WB5LUA on 5760.1 MHz over a 42 mile path. LUA's SSB signals were good and clear, VJB's CW had a T9 note. VJB's 25 milliwatts of SSB was just detectable over this path.

What made this QSO unusual was the Local Oscillator. No Crystals, No PLL's, No multiplier stages, just a free running oscillator.

Yes, the commercial DRO Oscillators showing up on the surplus market are stable and the Phase Noise is low enough to run SSB or CW.

Drift was 1 to 2 KHz per min. This was a nuisance, but Gee Wizz, I've owned Swan 250's that drifted worse than this. The prototype had some layout problems. The DRO only generates .2 watts of heat, my drift problem was caused by other parts located near the DRO heating it up, an easy fix!

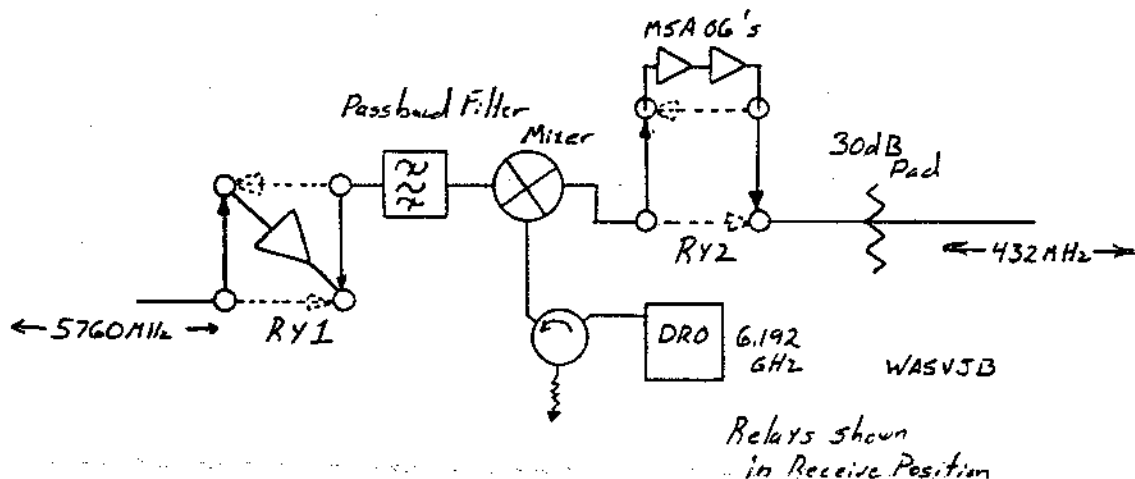

The transverter is straight forward. One trick was to use the power amp as the preamp, reversing it with a transfer relay. I plan to add another stage, this will boost the power amp to it's full 250 Milliwatts out, and lower the noise figure.

The Collins Passband filter is tight enough for a 144, or even a 50 MHz IF, but I used a 432 MHz because that was as low as the DRO would tune. The DRO is very load sensitive, the circulator on it's output helped a bunch.

I have the parts for a 10 GHz version, maybe by the next FEEDPOINT.

Kent Britain WA5VJB

TNX NTMS "FEEDPOINT"

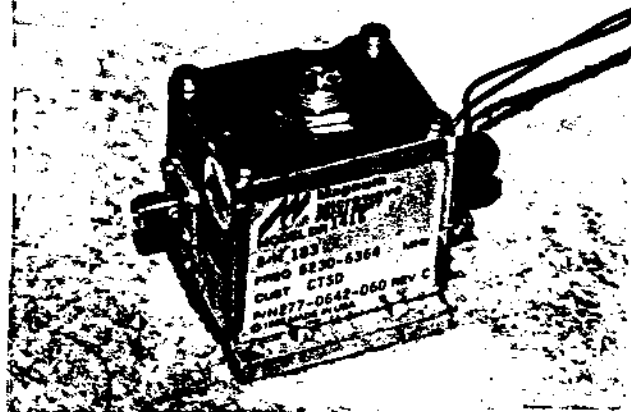
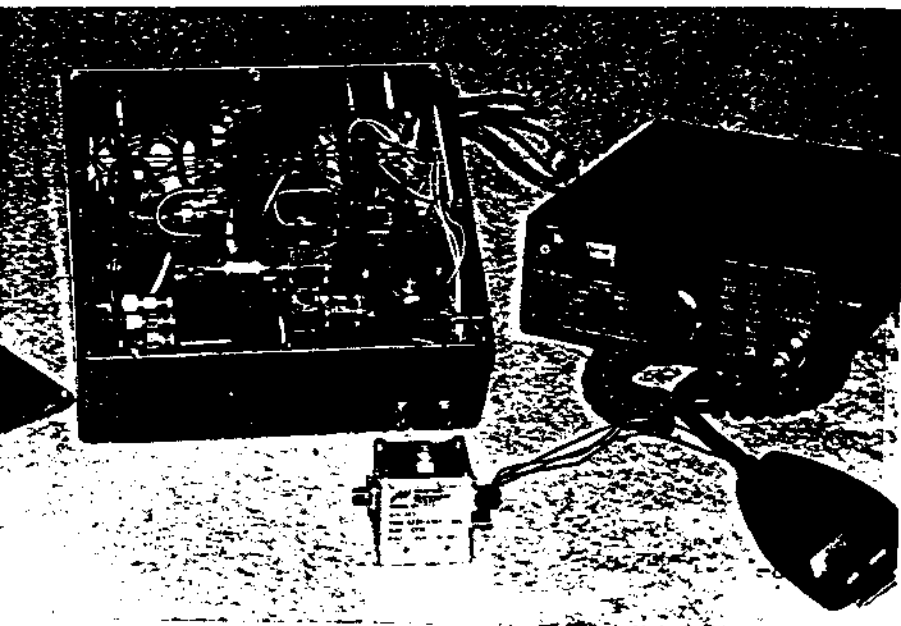

DOWN EAST MICROWAVE

MICROWAVE ANTENNAS AND COMPONENTS

BILL OLSON
W3HQT

BOX 2310 RR1
TROY, ME 04987
(207) 948-3741

CRAIG HENDERSON
N8DJ8

Ph. (419) 352-4465
Hrs. 10-5



C. A. T. S.
Rotor Parts & Repair



7368 S.R. 105

Pemberville, OH 43450



215-288-0325

W3HK

GEORGE S. VanDYKE, JR. P.E.

1737 Scattergood St.
Phila., PA 19124

The R.F. Connection "Specialists in RF Connectors and Coax"

K43QPG

Joel Knoblock
301/840-5477
Fax 301/869-3680

Order Line 800-783-2666
Suite 11, 213 N. Frederick Ave.
Gaithersburg, MD 20877

(302) 328-7728
ORDER LINE 800-441-7008



Delaware Amateur Supply

"AMATEUR SALES AND SERVICE"

PAUL WA3QPX
KATHY KA3IYO

71 MEADOW ROAD
NEW CASTLE, DELAWARE 19720

(215) 650-5800 DAY
(215) 343-2448 NIGHT

INDUSTRIAL
COMMERCIAL
RESIDENTIAL

WARRINGTON ALARM CO.

LOCKSMITH • BURGLAR • FIRE

BOB HERSHMAN

417 DAVISVILLE ROAD
WILLOW GROVE, PENNA. 19090-3483

215-342-5982

WA3HIT

Paul and Betty Rilling

INCOME DIVERSIFICATION

5830 Weymouth Street -Phila., Pa. 19120

Gerry Rodski - K3MKZ

717-868-5643
6-10 PM

SSB ELECTRONIC U.S.A.
Call for Catalog

124 Cherrywood Dr. Mountaintop, Pa 18707

609-541-0120

Bob Fischer Company, Inc.

AERIAL LADDERS • UTILITY EQUIPMENT

BOB FISCHER
PRES.

28TH & LINCOLN AVE.
CAMDEN, N. J. 08105

ZD Engineering

Specialists in CATV Hardline
Matching Transformers-Power Dividers
and Related R.F. Devices

144 MHZ-1296 MHZ..

TO FIT 1/2, 3/4 AND 7/8 INCH HARDLINE.

PAUL H. DARWACTOR
(419) 424-8765

W8ZD

805 Salsley Ave.
Findley, Ohio 45840

DESTINATIONS INC.

A FULL SERVICE TRAVEL AGENCY

HARRIET SOLTOFF TRAVEL CONSULTANT

616 SOUTH THIRD STREET
PHILADELPHIA, PA. 19147

RES. (215) 947-4483

MONSIEUR-THUR 7-11 PM
SAT. 9-11 PM

Day-Nite (215) 455-2121

FERTIK'S ELECTRONICS

Components & Equipment

LEON FERTIK

5400 ELLA STREET
PHILADELPHIA, PA. 19120

ARROW

RICHARD E. COMLY

TOOL, DIE & MACHINE CO., INC.
2065 BENNETT RD. PHILA., PA 19116



(215) 676-1300
FAX 934-5237

(808) 268-0736

RICHARD CONNOR



RECON Communications

- COMMUNICATIONS TOWER MAINTENANCE
- ANTENNAS, FEEDLINES, TOWERS INSTALLED
- TOWER PAINTING, RE-LAMPING, RE-GUYING
- RF SYSTEM TROUBLESHOOTING
- LIGHTNING PROTECTION, GROUND SYSTEMS

Emergency Service

412 Carrenza Road
Tabernacle, NJ 08088

(302) 328-7728
ORDER LINE 800-441-7008



Delaware Amateur Supply

"AMATEUR SALES AND SERVICE"

ROB WA3QLS
GAIL KA3ITN

71 MEADOW ROAD
NEW CASTLE, DELAWARE 19720

(215) 745-6173
(302) 886-7630
(215) 342-6832



COMPU-SIMPLE, INC.

COMPUTER APPLICATIONS FOR SMALL BUSINESS

ELLIOTT J. WEISMAN
Consultant

P.O. BOX 7161
WILMINGTON, DELAWARE 19803

RUTLAND ARRAYS

For the finest VHF/UHF antennas
1703 WARREN ST.
NEW CUMBERLAND, PA 17070

Call or write for our new catalog!
(717) 774-5298 7-10 pm EST

Hopkins & Yampolsky, P.C.

ATTORNEYS AND COUNSELLORS AT LAW
1814 SPRUCE STREET
PHILADELPHIA, PENNSYLVANIA 19103

STEVEN N. WHITE
WA3IAO

TEL. (215) 545-1300

FIRST CLASS

PACK RATS

DICK HUNTZINGER
W3FD
130 FAIRHILL RD.
CHURCHVILLE, PA 18966

M 12/92



MEETING
NOTICE



412 Carranza Rd
Tabernacle, NJ
08088
Cheese Bits

ICOM

CES
SEI

Saxton

CDE

nbt

GILFER

TPL

W

Weller

hy gain

ASTATIC

DRAKE

LMB

callbook

waldom

communications specialists

Larsen Antennas

"W2AU" HAM-KEY
Beancat

ROHN

If we're
judged by the
company we
keep, we should
do pretty well!



"HAM" BUERGER, INC.
Electronic Equipment Distributor

"Right in the middle of a lot of good company!"

417 DAVISVILLE ROAD
WILLOW GROVE, PA 19090
215-659-5900

Service Since
1956

BIRD

MISCO

Vector

OMK

HUSTLER

phelps
dodge
Communications Equipment

VIBROPLEX

NPC

MEJ

AMCO

SOMAR

TEN-TEC

TRW

SWAN

COVER CRAFT

AMP
SPECIAL
INDUSTRIES

Sorath

TAB BOOKS
Cushcraft

AMPHENOL

BW

ICR

TELEX

SPRAGUE

Xcelite

Wilson Electronics Corp.