

PACK RATS'



PACK RATS

CLUB CALL: W3CCX

MT. AIRY VHF RADIO CLUB, INC.

CHEESE BITS



MT. AIRY VHF RADIO CLUB., "THE PACK RATS", PHILADELPHIA, PA. W3CCX
 NET FREQUENCIES: 50.125, 144.150, 222.125, 224.58/222.98, 432.110, 903.100, 1296.100 MHz
 AFFILIATED CLUB: AMERICAN RADIO RELAY LEAGUE ARNS

Meetings: Third Thursday of each month at 8:00 PM
 Southampton Free Library, 947 E. Street Road
 Southampton, Pennsylvania 18966

SCANNED TO PDF BY BERT, K3IUV, 2013

VOLUME XXXIV

AUGUST 1992

NUMBER 8

THE PREZ SEZ

I am writing this in the Tulsa, OK airport on my way to the Central States VHF Conference. Let's give a round of applause to the new Vice President and directors. I have been reelected for another year and with your help we will make it a great one.

At the board of directors meeting in July we decided to try a novel approach and develop a questionnaire. This will be used to poll all club members on matters concerning the direction the club will go in the next year. Please take a few minutes to fill out the form and return it. As I mentioned in a earlier column the club is at a cross roads. With your input we will decide which is the best path to take.

I missed the regular club meeting but our new VP, Paul, WB3JYO filled in and did an excellent job.

I find the various VHF and Microwave conferences to be an excellent way to recharge your ham batteries. They allow you the opportunity to experience Ham Radio as others do. It gives you a different perspective of VHF/UHF and Microwave activity. We are lucky to live in the area we do with its high population density as it makes for interesting VHF contests. But in other parts of the country with lower activity levels most Ham's do other things. Such as EME, Meteor Scatter, or Rovering to name a few. They then tend to use the conference to show and tell others of their activities and accomplishments. If you have never attended a conference why not start with our own Pack Rat Mid Atlantic Conference on 3 October, 1992?

(Continued on page 4)

NOTICE: The Annual Club Picnic will be held at the QTH of Dave, N3CX on 9 August.

Pack Rats CHEESE BITS is a publication of the Mt. AIRY VHF RADIO CLUB, INC. Philadelphia, PA. and is published monthly.

SUBSCRIPTION RATE: \$10.00 PER YEAR (USA)
 \$12.00 PER YEAR (CANADA)
 \$15.00 PER YEAR (ELSEWHERE)

We operate on an exchange basis with other publications. Anything that is printed in CHEESE BITS may be reprinted, unless otherwise stated, provided proper credit is given.

DEADLINE FOR ARTICLES AND SWAP SHOP IS THE MONTHLY MEETING DATE. NON-COMMERCIAL SWAP SHOP ITEMS-FREE OF CHARGE.

SUBSCRIPTION/ADVERTISING MANAGER:

Bob Fischer, WB2YEH
 7258 Walnut Avenue
 Pennsauken, NJ 08110
 (609) 665-8488

EDITOR:

Harry Brown, W3IIT
 3012 Potshop Road
 Norristown, PA 19403
 (215) 584-4846

CLUB TREASURER:

Dave Mascaro, WA3JUF
 1603 Mink Road
 Ottsville, PA 18492
 (215) 795-2628

AWARDS CHAIRMAN:

Joe Kilgore, W2EIF
 (609) 783-9478

TRUSTEE OF CLUB CALL - W3CCX

Ron Whitsel, WA3AXV
 (215) 355-5730

PACKRAT 222 MHz REPEATER - W3CCX/RPTR
 222.98/224.58 MHz, Churchville, PA

OFFICERS: 1991-1992

PRESIDENT: W4RSJ, Bill Murphy
 VICE-PRES: WB3JYO, Paul Drexler
 REC. SECR: WA3AQA, Walt Zumbach
 TREASURER: WA3JUF, Dave Mascaro
 COR. SECY: WA2GFP, Geoff Krauss
 DIRECTORS: N3AOG, Dick Comley (1 YRS)
 WA3NUF, Phil Miguezlez (1 YRS)
 N3EXA, Brian Taylor (2 YRS)
 K3ESJ, Bill Jaxheimer (2 YRS)

MONDAY NIGHT NETS

<u>TIME</u>	<u>FREQ.</u>	<u>NET CONTROL</u>
7:30 PM	50.125 MHz	K3EOD
8:00 PM	144.150 MHz	W2EIF
8:30 PM	222.125 MHz	WB2YEH
8:30 PM	224.58R MHz	K3ACR
9:00 PM	432.110 MHz	WA3AXV
9:30 PM	1296.100 MHz	WA3NUF
10:00 PM	903.100 MHz	N3AOG

COMMITTEE CHAIRMEN

LADIES' NIGHT: WA3YUE 215-666-1558
 JUNE CONTEST: N3CX 215-679-7293
 HAMARAMA: K3EOD 215-742-3312
 VHF CONFERENCE: KB3XG 215-766-2643



THE AMERICAN RADIO RELAY LEAGUE

OST

HUGH A. TURNBULL, W3ABC
 Director, Atlantic Division

6903 RHODE ISLAND AVE.
COLLEGE PARK, MD. 20740

(301) 927-1797

1-302-478-2757

**AMATEUR
and
ADVANCED
COMMUNICATIONS**

G. B. WALLS

3208 CONCORD PIKE (RT. 202)
WILMINGTON, DEL. 19808

Graphic Design Illustration Production



Lynne D. Whitsel

209 Frog Hollow Road
Churchville, PA 18966
215 355-5730

Calendar of Coming Events-August 1992

- 1-2 ARRL UHF Contest. See July QST, page 97 for the rules.
- 8-9 Maryland-D. C. QSO Party. See July QST, Page 98 for the rules.
- 9 The August meeting of the Packrats will be a family picnic with all Packrats, friends, wives, kids, etc. invited. The picnic will be held at the QTH of Dave, N3CX. Call Sylvia, Dave's XYL at 215-679-7293 if you wish to bring a covered dish to share. Start time is noonish. Bring your swim suits. Rain date is Aug. 16.
- 9 Mid-Atlantic ARC Hamfest at the Bucks County Drive-In Theater on Rte 611 in Warrington, Pa. Five miles north of Exit 27 of the Pa. Turnpike. Talk-in on 146.66/.06 and .52.
- 11 Perseids Meteor Shower predicted peak at 2210 UTC. See note elsewhere in this issue of Cheesebits from W3EP.
- 13 Packrat Board of Directors meeting at the QTH of Ron, WA3AXV. Call 215-355-5730 for directions.
- 14-16 East Coast EME Meeting will be held at the Oxon Hill Ramada Inn in Oxon Hill MD. For further info contact Willy Mank, W1ZX, Hwy 228, Box 144D, Waldorf, MD 20603.
- 15-16 First weekend of the 7th ARRL Cumulative 10 GHz Contest. See page 78 of the June QST for rules. Second weekend is 19-20 Sept.
- 16 The Delaware-Lehigh Amateur Radio Club Hamfest will be held at the Plainfield Township Fairground in Easton, PA. on PA 191. TI on 146.7R and .52. VE exams at 1 PM.
- 16 The Delmarva Hamfest will be held at the Delaware Technical Community College In Georgetown, Delaware. Talk-in on 147.675/.075, and 224.24/.84.
- 17 Lunar Apogee
- 22 Ramapo Mtn ARC Hamfest in Oakland, NJ. Talk-in on 146.49/.19 and 146.52.
- 23 Gloucester County ARC Hamfest at the 4-H Fairgrounds in Mullica Hill, N.J. Talk-in on 147.78/.18, 223.06/224.66 and 146.52.

SOME TIPS FOR USING PLL BRICK OSCILLATORS

By Chuck Steer, WA3IAC

The power supply used to power the oscillator in the 10.368 GHz Transverter has one shortcoming. The MTP3055 used in for Q3 will not work well under load. Some improvements to the power supply used to convert +12 volts to -19 volts are replacing Q3 with a 2N5887. Doing so will not require a change to the circuit. Another Q3 replacement is to use the Motorola MPT 3055E and replace the 5.1 v. zener diode and luf capacitor with a 1 Kohm resistor.

Another tip is to set the PLL voltage at 0 phase output to about -8.0 volts. The lock range is between -3.5 and -15 volts. To do this, first let the oscillator run for about an hour. With a DVM monitoring the voltage, adjust the pot located on the side of the unit. Now, when the unit is turned on from a cold start you will get lock and stay locked. Should the voltage be set to -7.5 to -8.5 volts when cold, loss of lock could accrue as the oscillator heats up.

THE PREZ CONTD

This will be held at the Sheraton Hotel in Cherry Hill New Jersey. If possible, plan to stay overnight and bring the family. There will be plenty for them to do from a day trip to Philadelphia or Atlantic City or just plain shopping. I am sure you will make new friends and just might get recharged. And the next morning you just go across the street for the HAMARAMA hamfest at the Garden State race track.

William T. Murphy
WORSJ, FN20JR

HAMARAMA MEETING

By Al Boblitt, K3EOD

A Lick, Stick and Peel session (to mail out flyers) will be held on 22 August at the QTH of Bob, WB2YEH, 1245 Walnut Ave., Pennsauken, NJ at 10:00 AM. Following this session, there will be a short meeting of each committee. Committee members are requested to bring a list of special needs and materials they may need.

THE 1992 CENTRAL STATES VHF SOCIETY CONFERENCE

By Bill Murphy, WORSJ

This years Central States VHF Conference was held at the YO Hilton in Kerrville, TX. Approximately 200 people attended. Along with the normal assortment of stateside people, I noted G4FUF, EZP, XE1GE and VK4APG. A number of VHF and Microwave papers were presented along with the antenna and noise figure measurements sessions (see attached info).

An excellent presentation on Lightwave Communications was given by Dave Chase, KY7B, and Terry Wilkinson, WA7LYI. AL Ward, WB5LUA, spoke on using TV carriers for propagation beacons. Kent Britain, WA5VJB, spoke on exploiting aircraft scatter just to name a few. The Proceedings are published by the ARRL and are available for \$12.00.

I had an opportunity to visit the QTH of Bill and Matti Tylan, W3XO/5, and attend a TEXAS style barbecue. Many thanks to Bill and Matti for their grand Texas hospitality. The 1993 conference will be held in Oklahoma City with the 1994 conference to follow in Memphis.

Items of interest to the Pack Rats is a call for the formation of a VHF/UHF/Microwave Council with representation from all the major VHF clubs. The purpose will be to act as a single voice for all issues in the Amateur weak signal community. In addition a call went out by Paul Shuch, N6TX, to document activity in the VHF/Microwave bands on video tape. These tapes will be saved in a library and later shown to the FCC in defense of weak signal frequencies. It seems that some FCC staffers only look at the repeater directory for information on band occupancy.

By the way Paul is now our neighbor and is living in FN11.

NEWS FLASH: W3IP has provided an update for the peak of the Perseids Meteor Shower. This shower is now predicted to peak on 11 AUG 1992 at approximately 2210 UTC (see attachment). This shower occurs on August 10 to 13 and is expected to be the best in years.

Ham's in attendance at the conference from the local area were W2AXU Jack Powers and his XLY Florence plus myself.

Membership Changes

The following members have been dropped from our members rolls: W3BRU, WB3CTP, K3HW, WA3NDE, KE2OI, WB2RVX, WA3TSE, W3UBO, W3VIR AND K3VYG.

SWAP SHOP

Send non commercial swap shop items to the editor.

For Sale:

Wanted: 144 MHz Meteor Scatter Skeds from NØHZJ, EN34. Contact Rich at 612-934-7580.

Wanted: 5 to 7 el 146 MHz yagi. Will swap a 6.1 GHz Gunn oscillator food for a 5760 LO with 10 mw output. Contact: Chuck Steer, WA3IAC at 215-335-0637 after 6 PM.

For Sale: 20 Watt TWT Amplifiers, 40 dB gain min., tested, call for more details w/power supply, run on -24VDC, 5.7 GHz band \$125, 10-10.5 GHz used \$150, new \$275. WR-90 WG (Wave Guide) over 800 feet, lengths from 1' to 10', 2.50 per foot for short pieces, copper with WE flange, adapts to standard RG-91 (X) flange with some drilling. SMA SPDT relays, 28VDC, DC-18GHz, Like New-removed from equip. \$45. SMA Transfer relays, 28VDC, DC-12.4 GHz, \$40. Amplifiers, .2-2.8 GHz, 20 dB gain, 2.5 dB NF, Avantek UTO2012-2013 cascade, +22 dBm output, \$30 great for drivers or high intercept pre-amp. PLO bricks all types, lots of 11.2-12.7 GHz for 10.3, \$20-\$50. WJ M-79 X-Band double balanced mixers, NEW, \$25, pin-type. Lots More Stuff, call. WA3ZKR Jeff Kruth, 2600H Cabover Dr. Hanover, MD. 21076 410-768-6666 days, 410-750-7744 eves.

COMMERCIAL AD

LOOP YAGIS: 902 MHz 33 element \$89 kit, \$109 assembled and tested. 1296 MHz 45 element, \$89 kit, \$109 assembled and tested. 1296 MHz 55 element "Sooper Looper" \$99 kit, \$124 assembled and tested. 2304 MHz 45 element \$75 kit, \$89 assembled and tested. Also available: element and hardware kits for the above. 2 and 4-way power dividers. Discount on complete arrays. Solid State Linear Power Amps, 13 VDC: 1296 - 8W in 35W out \$315, 1W in 20W out \$265, 4W in 70W out \$695. GaAs FET Preamps: 903 MHz .8dB NF \$90, 1296 MHz .8 dB, 2304 MHz 1 dB max NF \$140. SHE SYSTEMS No-tune Transverter kits, w/144 MHz IF now available for 903 through 3456 MHz. Write or call for complete catalog. DOWN EAST MICROWAVE, Bill Olson, W3HQT, Box 2301 RR-1, Troy, Maine. For information and orders telephone (207) 948-3741.

New Membership

At the July outdoor meeting, Scott Sellers, N3GSA was voted in as our newest member. His address is: 1386 Cobbler Road, Quakertown, PA 18951, phone 215-538-7131.

CHEESEBITS SUBSCRIPTIONS

Cheesebits subscriptions are available to everyone interested in activities and information from the VHF thorough the microwave frequencies. Subscriptions are for 1 year of 12 issues. For a subscription, send the following information:

----- Name:

Name: _____ Call: _____

Street Address: _____

Town: _____ State: _____ ZIP: _____

Subscription Rate: \$10.00 per year (USA), \$12.00 (Canada), \$15.00 (Worldwide)

Send to: SUBSCRIPTION/ADVERTISING MANAGER:
Bob Fischer, WB2YEH
7258 Walnut Avenue
Pennsauken, NJ 08110

Dave Zimmerman, W3ZD, Memorial Fund
By Al Boblitt, K3EOD

On behalf of the Dave Zimmerman family, I am pleased to announce that we have received contributions in the amount of \$350.00 which is being sent to "The United Mission" in Nepal to provide free medical care for poor patients.

I would like to thank the following Pack Rats and friends of Dave for their generous contributions to the Memorial fund: K3AJS, WA3AQA, N3CX, W3CXU, K3DLS, WA3EHD, K3EOD, K3ESJ, W3HK, WA3JUF, K3KKN, WA2OMY, K3PHY, WB3PHY, WØRSJ, WB2YEH and Sylvia Stein.

Additional contributions in Dave Zimmerman's name may be made to:
Free Care for Poor Patients
Treasurer
United Mission to Nepal
Box 126
Kathmandu, Nepal

W3CCX June 1992 VHF CONTEST SUMMARY
By Dave Hackford, N3CX

What a beautiful weekend we had this year on top of Mt. Camelback. The weather was just great and all of the equipment worked as planned. Everyone who went did a bang up job in making this contest and enjoyable event. The following list is a rough QSO and grid total (the log hasn't yet been dup'd).

<u>BAND</u>	<u>QSOs</u>	<u>Grids</u>
50 MHz	591	186
144 MHz	550	56
222 MHz	108	28
432 MHz	181	37
903 MHz	42	17
1296 MHz	43	18
2304 MHz	61	20
3456 MHz	27	12
5760 MHz	4	3
10 GHz	5	3
24 GHz and up	6	4

I would like to thank the following for their help: WA3AXV, N3BBI, WU3C, N3CX, WB3DNI, K3ESJ, N3EUV, N3EXA, N3GSA, W3IIT, N3ITT, WA3JUF, WB3JYO, N2MVT, WA3NUF, WØRSJ, WB2YEH, WA1YHO, WA3YUE, WC2K, KB3XG, and N3AOG. One final comment: Now is the time to plan and start building "bullet proof" transverters for next year's contest. Don't put it off. Listen for the weak ones.

Ed Note: From the Upper Midwest VHF/UHF Newsletter some score highlights: 834 QSOs in 271 grids on 50 MHz by WØUC in EN44, 62 grids on 144, 34 grids on 222, 44 grids on 432 and 20 grids on 1296 by NN9K in EN31. And speaking of rovers, W7XU/R operated in 14 grids and traveled over 1200 miles. At least part of the Mid West had Es on 144 MHz.

HEALTH AND WELFARE

Bob, WB2YEH continues to recuperate from a busted toenail.

Believe it or not, summer is half over. We should be thinking about HAMARAMA and what part each of us will play in making it the biggest and best hamfest on the east coast.

The following list shows the names and phone numbers of the committee chairman. Look over the list now and call the chairman of the committee that you would like to work on and offer your support.

<u>Position</u>	<u>Call</u>	<u>Name</u>	<u>Phone Number</u>
Hamarama Chairman	K3EOD	Al	215-742-3312
Registration	WB3DNI	Pat	215-672-5289
Night Time Parking			
Tailgate Parking	WA2OMY	Gary	215-539-5289
Buyer Parking			
Tailgate Collection	WA3NUF	Phil	215-675-4277
Ticket Sales	W3HMU	Tony	215-847-5017
Signs	WB3JYO	Paul	609-538-1637
Talk-In Station	WB2YEH	Bob	609-665-8488

Remember, HAMARAMA is not a one man operation. It takes a lot of dedicated people working together to make it a success. Let each and everyone of us start talking-up HAMARAMA not only on the air, but every time we meet a fellow ham. In addition, let's pass out flyers at all the hamfests that we attend. Contact K3EOD for a supply of flyers.

Interesting Stuff from other Newsletters

The July issue of QEX has an article on T/R switching of Low Power 903 and 1296 MHz Transverters.

The June/July issue of the VHF/UHF DXer (from the UK) has articles on 4 types of elevation systems, Power Combiners and a modification of the FT290R Mk II to drive external relays.

The NTMS newsletter for July/Aug has an article from the May 1992 RSGB Microwave Newsletter with hints on 10 GHz DXing. Also there is an article on an antenna element shear that will work for elements up to 1/4 inch and a Gunn Diode power supply/modulator. It also had a couple of "Rat" articles ala Cheesebits.

The July issue of "terrestrial VHF+" tells how to make 7/8 inch hardline connectors from standard plumbing parts.

QST for August 92, page 60 has a "Hint and Kink" note on curing oscillations in the MSA-0885 MMIC.

See the editor for copies of these exchange papers (except QST).

Corrections for the 1992 Perseids Date/Time

By Emil, W3EP

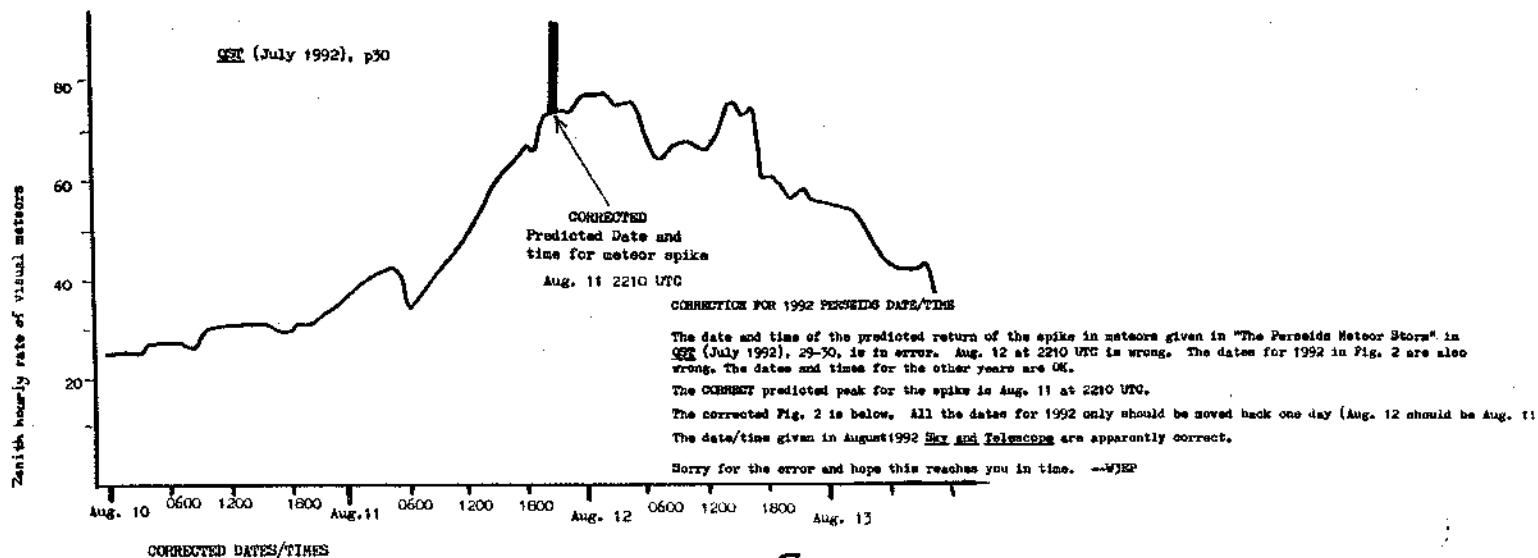

Eighteenth Annual Eastern VHF/UHF Conference

By Dave Hackford, N3CX

Back in February of this year, I received a land line from Tom Kirby, W1EJ. He was looking for interested hams to give a talk at the conference on the weekend of 23 May. I said yes and then forgot about it for a while. As the time slipped by I was thinking that I haven't been to the New England gathering in about 5 years or more. I must say that these events are worthwhile going to if you can slip away. Not only do you get to keep the brain cells active hearing all the latest technical scoop from EME to Tower Loading and Band discussions. In addition, you also have a great time meeting old friends- HI. It was great to see everyone again. The conference was held at the University of Hartford, Ward College of Technology. Tom Kirby, W1EJ, and the Eastern VHF/UHF Society did a bang-up job putting on a welcome affair. If you get a chance to go next year, do so. Don't forget that this fall there are a lot of events for the VHF/UHF/Microwave enthusiast. Microwave Update is being held in Rochester, NY this year on the 3rd weekend of October (the grouse are safe for a weekend HI). By the way, the proceedings are available from W1EJ. Listen for the weak ones.

High Level Rx Mixer Modifications for the 903 MHz "No-tune" Xvtr

By Dave Hackford, N3CX

Well, here it is again, 5 days till the June VHF contest and all the things that I was going to do over the winter to improve the Rx performance of my notune in strong RF environments was not started-HI. As all of you Rats know, our June contest QTH has very strong signals on all bands, so a high level mixer (high dynamic range) is a necessity so you can live thru the weekend. That's enough talk, so on to the mod. The mixer I used was a Mini Circuits SRA-173H, costing about 31 plasters. This high level mixer requires about =17 dBm (50) mw of LO to really turn it on. So first, I checked how much LO drive was at the Rx input to the mixer. I measured pretty near to 6 mw. so I needed approx. 10 dB gain. That was quick and easy --ah a Mimic. I looked in the Mini Circuits book and a MAV-11 mmic looked like a good choice, 11.5 dB gain at 1 GHz and +16 dBm output at the 1 dB compression point. I had a few of these in stock, so let's get started. About half way between the Wilkinson power divider and the receive mixer drill a hole in the 50 ohm line so as to clear the diameter of the mmic. I put two rivets thru the ckt board for grounding of the mmic leads. I cut two places in the 50 ohm line for the chip caps. I used what I had in the parts cabinet- about 1000 pf. and 1/2 watt 100 ohm bias resistors. THE THE RFC was the same as used on the notune tx strip. I drilled a small hole for a solder-in feedthru cap (470 pf) near the mmic for the supply voltage which I brought across the top of the board from the oscillator circuit. On the placement of the mixer, you'll have to cut the microstrip and modify the pin-out to match the notune. I use copper foil cut in strips for these connections. The LO and RF ports can be switched per the Mini Circuits catalog. I terminated the IF output in a 3 dB pad using 1/4 watt, 2% resistors. This could be improved but at the time I was pressed for time. Final checkout was on the mountain top and it worked great, no overload, clicks, pops, etc. I could tune within 5 kHz of the real strong signals.

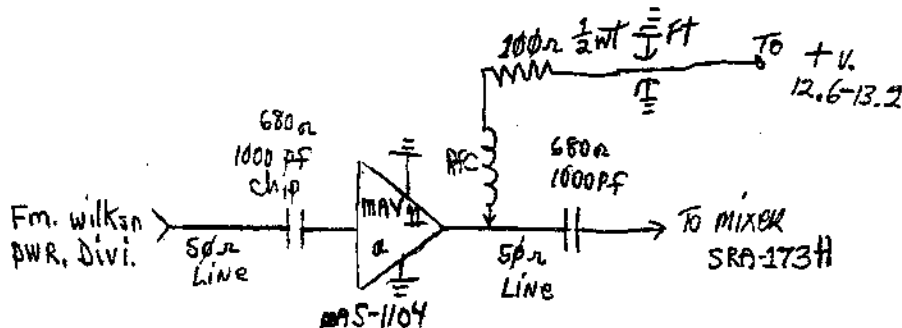

High Level Mixer LO Buffer



MT. AIRY V.H.F. RADIO CLUB, INC.

PHILADELPHIA, PENNSYLVANIA
CLUB MEMORIAL CALL

W 3 C C X



PACK RATS FREQUENCIES

144.15 - 50.125 - 220 RPTR
432.11 - 1296.025 MHZ.
220.125

RANDY THOMPSON, K5ZD
CAC CHAIRMAN
3983 THREE DEGREE RD.
RENFREW, PA 16053

29 May 1992

ADDRESS CORRESPONDENCE TO:

24 MAIN BLVD
TRENTON, NJ 08618

Randall A. Thompson
K5ZD/3
398 Three Degree Road
Renfrew, PA 16053
(412) 586-5721

June 4, 1992

Mt. Airy VHF Radio Club
Paul Drexler, WB3JYO
24 Main Blvd
Trenton, NJ 08618

Dear Randy:

The Mt. Airy VHF Radio Club (The Packrats) have been in contact with a number of active VHF'ers and VHF clubs regarding a possible change to the rover definition in ARRL contests. After considerable thought and discussion we recommend rephrasing the rover definition as follows:

ROVER CATEGORY

"A rover shall consist of one or two operators that move between two or more grids making contest contacts via emergency power, using the same equipment and antennas at each site. Rovers sign "rover" on phone and /R on CW after their call sign. The intent of the rover category prohibits fixed station scores to be included with rover operations; stations may however, enter the "rover class" with a separate log for rover activities.

The rover scoring remains unchanged from that printed in Dec 91 QST (i.e. total number of QSO points from all bands times the total number of multipliers from all grid squares).

Thank you for your efforts in this matter; I am certain the CAC will correct this oversight. Please us know how The Packrats may be of assistance to the CAC.

73,

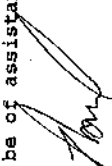
Paul Drexler, WB3JYO
Corresponding Secretary

Dear Paul:

Thank you for your letter suggesting a new definition for the Rover category in ARRL VHF contests. Congratulations on a very well crafted proposal. I will forward your letter on to the Contest Advisory Committee for consideration.

I only have one comment on your wording. Why do you include the requirement that the Rover station must use "emergency power". What is the definition of emergency power? Without a clear definition, this could be confusing or cause future controversy. What's wrong with a Rover using commercial power?

If you insist on some form of portable power source, may I suggest changing the wording to "making contest contacts using the same equipment and antennas at each site, using non-commercial power sources."

Thanks for your contribution to the ARRL contest program.

73.

Randall A. Thompson, K5ZD/3
Atlantic Division Representative

cc: CAC c/o Lisa Arel

73. We'll be talking with you in the June contest!

ARRL

26th Central States VHF Society Conference
Antenna Gain Measurement Results
17 July 1992 -- Kerrville, Texas

26th Central States VHF Society Conference
Preamp Noise Figure/Gain Measurement Results
17 July 1992 -- Kerrville, Texas

* = indicates Reference Antenna
COM = Commercial

* = indicates Category Winner
HB = Homebrew

N/Figure = Noise Figure
HB = Homebrew

* = Category Winner
Com = Commercial

(Test equipment consisted of HP 8970 with HP 346B noise source and calibrated 6 dB attenuator.)

144 MHz GAIN (dBd)	CALL	COM/HB	DESCRIPTION
16.8	K6HYC	Com	M2 24-el. Yagi, 54' boom
12.7	W3XO	Com	Cushcraft 215WB with trigonal
12.7	W3XO	Com	Cushcraft 215WB w/o trigonal
* 10.8	WDSAGO	HB	8-el. Yagi (mod. JR), 12' boom
9.3	KA2KQM	Com	Cushcraft 11-el. mtd. on Jeep
# 9.0	WBOTEM	HB	8-el. Yagi, Reference Antenna
7.5	WSUC	HB	7-el. Yagi, 6' boom
1.5	WDSAGO	HB	Turnstile Omni
1.5	W5OZI	HB	Big Wheel
1.0	AA5IB	Com	M2, 2 Scooops stacked vert. in phase
0.7	WA5VJB	HB	Mag mount halo
0.0	WA5VJB	HB	Scoop #2
0.0	WBOTEM	Com	M2 Scoop
-0.5	WBOTEM	HB	Mobile halo
-3.0	WA5VJB	HB	Scoop #1

222 MHz GAIN (dBd)	CALL	COM/HB	DESCRIPTION
# 13.1	WBOTEM	HB	13-el. Yagi, Reference Antenna

(Note: No antennas were measured on 222 MHz.)

432 MHz GAIN (dBd)	CALL	COM/HB	DESCRIPTION
# 15.2	WBOTEM	HB	19-el. Yagi, K2RIW, Reference Antenna
* 13.1	K5IS	HB	15-el. yaagi, 12' boom
9.2	WDSAGO	HB	Dish feed, 1/2 loop above gnd.
8.9	N5GUE	Com	5-el. Yagi
7.0	K5TJ	HB	13-el. quad, 64 3/4" boom
0.3	WA5VJB	HB	Mag mount halo

902 MHz GAIN (dBi)	CALL	COM/HB	DESCRIPTION
* 15.4	K9KFR	HB	20-element 910 MHz Yagi
# 14.3	WA5VJB	HB	Yagi, Reference Antenna
14.1	KOFOA	HB	902/1296 VJB feed on 3' dish
6.5	NOSK	HB	Ridged horn (NIST Ref.)

1296 MHz GAIN (dBi)	CALL	COM/HB	DESCRIPTION
# 17.9	KOFOA	HB	902/1296 VJB feed on 3' dish
# 14.2	WBOTEM	HB	11-element Yagi, Reference Antenna
8.1	NOSK	Com	Ridged horn (NIST Ref.)
5.6	WDSAGO	HB	Alford slot

2304 MHz GAIN (dBi)	CALL	COM/HB	DESCRIPTION
* 21.6	KOFOA	HB	WA3RMX feed on 3' dish
# 13.4	WA5VJB	HB	Feedhorn, Reference Antenna
9.6	NOSK	HB	Ridged horn
8.4	K5UGM	Com	Log periodic
3.4	NOSK	HB	11-element log periodic

3456 MHz GAIN (dBi)	CALL	COM/HB	DESCRIPTION
# 16.6	WA5VJB	HB	12"x9"x12" feedhorn, Reference Antenna
* 25.6	KOFOA	HB	WA3RMX feed on 3' dish
10.6	K5UGM	Com	Log periodic (1-12 MHz)
10.2	NOSK	HB	Ridged horn (modif.)
10.0	NOSK	Com	11-element log periodic

5760 MHz GAIN (dBi)	CALL	COM/HB	DESCRIPTION
* 22.7	KOFOA	HB	WA3RMX feed on 3' dish
# 21.5	WA5VJB	HB	Feedhorn, Reference Antenna
12.2	NOSK	HB	Ridged horn (modif.)
9.9	K5UGM	Com	Log periodic

50 MHz N/Figure	GAIN	CALL	COM/HB	DESCRIPTION
* 2.54	32.94	W5DS	HB	6 to 2 converter

144 MHz N/Figure	GAIN	CALL	COM/HB	DESCRIPTION
* 0.07	20.55	WA5VJB	HB	MGF 2116
0.13	23.98	KH6CP/1	HB	MGF 1801
0.14	15.86	WA5VJB	HB	MGF 2116 #2
0.16	21.00	WA5VJB	HB	MGF 1801
0.19	24.00	WDSAGO	HB	MGF 1202
0.22	27.61	WA7CJO	HB	MGF 1801
0.27	22.38	WA5VJB	HB	MGF 2116
0.53	20.60	NOIS	HB	MGF 1402
0.95	18.42	NOIS	HB	MGF 1402
0.98	26.17	NOIS	HB	MGF 1402
1.02	17.95	W0PPF	HB	MGF 1202
1.42	11.81	WA4NJP	HB	NE 72083
1.74	19.77	KA2KQM	HB	NE 41137
2.07	20.77	N5KWB	Com	LA 2065R Daiwa
2.47	12.87	WA4NJP	HB	U310
3.73	9.26	KA2KQM	Com	Mirage mosfet

222 MHz N/Figure	GAIN	CALL	COM/HB	DESCRIPTION
* 0.16	20.62	WA5VJB	HB	MGF 1801
0.28	20.84	WA5VJB	HB	MGF 1801
0.91	21.45	WA4NJP	HB	NE 251
1.90	10.22	K5MAT	HB	U310
6.70	-4.37	WA5VJB	HB	NE 251 front end transverter

432 MHz N/Figure	GAIN	CALL	COM/HB	DESCRIPTION
* 0.25	20.54	NOCH	HB	MGF 1302
0.27	20.61	KH6CP/1	HB	MGF 1302 with BNC matching section
0.33	20.77	WA7CJO	HB	WA7CJO design
0.34	17.3	WDSAGO	HB	MGF 1412
0.44	18.79	KD4LT	HB	MGF 1302
0.45	15.54	NOCH	HB	MGF 1302
0.50	33.16	KD4LT	HB	MGF 1412-MGF 1402
0.50	18.19	W5DS	HB	MGF 1402
0.53	19.07	KD4LT	HB	MGF 1302
0.54	16.58	K5MAT	HB	MGF 1402
0.71	17.32	W3IWI	Com	ARRQ
1.56	18.64	NOSK	HB	MGF 1302

902 MHz N/Figure	GAIN	CALL	COM/HB	DESCRIPTION
* 0.37	17.25	W3IWI	HB	MGF 1402
0.40	17.67	AF1T	HB	MGF 1302
0.50	16.95	W5DS	HB	ATF 10135
1.31	13.47	WB4DEB	HB	MGF 1100

1296 MHz N/Figure	GAIN	CALL	COM/HB	DESCRIPTION
* 0.39	30.00	WDSAGO	HB	Fujitsu FXH35- MGF 1412
0.41	18.00	WDSAGO	HB	NE 321
0.45	14.85	KH6CP/1	HB	ATF 10135
0.49	17.33	KD4LT	Com	WDSAGO NE 321
0.65	16.46	K5XE	HB	MGF 1412
1.19	15.16	WA4NJP	HB	NE 720
4.79	21.40	N6TCM	Com	1-4 GHz amp

5760 MHz N/Figure	GAIN	CALL	COM/HB	DESCRIPTION
* 11.04	4.34	WA5VJB	HB	GaAs MMIC transverter

**DOWN
EAST
MICROWAVE**

MICROWAVE ANTENNAS AND COMPONENTS

BILL OLSON
W3HQT

BOX 2310 RR1
TROY, ME 04987
(207) 948-3741

CRAIG HENDERSON
N8DIB

Ph. (419) 352-4465
Hrs. 10-5



C. A. T. S.
Rotor Parts & Repair



7368 S.R. 105

Pemberville, OH 43450

215-288-0325



W3HK

GEORGE S. VanDYKE, JR. P.E.

1737 Scattergood St.
Phila., PA 19124

The R.F. Connection
"Specialists in
RF Connectors and Coax"

K43RPG

Joel Knoblock
301/840-5477
Fax 301/869-3680

Order Line 800-783-2666
Suite 11, 213 N. Frederick Ave.
Gaithersburg, MD 20877

(302) 328-7728
ORDER LINE 800-441-7008



Delaware Amateur Supply
"AMATEUR SALES AND SERVICE"

PAUL WA3OPX
KATHY KA3IYO

71 MEADOW ROAD
NEW CASTLE, DELAWARE 19720

(202) 588-1068
(215) 745-6173
(302) 806-7630
(609) 266-3668



COMPU-SIMPLE, INC.
COMPUTER APPLICATIONS FOR SMALL BUSINESS

BRIAN M. WEISMAN
Consultant

P.O. BOX 66374
WASHINGTON, DC 20035

215-342-5982

WA3HIT

Paul and Betty Rilling
INCOME DIVERSIFICATION

5830 Weymouth Street -Phila., Pa.19120

Gerry Rodski - K3MKZ

717-868-5643
6-10 PM

SSB ELECTRONIC U.S.A.
Call for Catalog

124 Cherrywood Dr. Mountaintop, Pa 18707

608-541-0120

Bob Fischer Company, Inc.

AERIAL LADDERS - UTILITY EQUIPMENT

BOB FISCHER
PRES.

28TH & LINCOLN AVE.
CAMDEN, N. J. 08105

DESTINATIONS INC.
A FULL SERVICE TRAVEL AGENCY

HARRIET SOLTOFF
TRAVEL CONSULTANT

616 SOUTH THIRD STREET
PHILADELPHIA, PA. 19147

RES. (215) 947-4483

MOVING-TABLE 7'-12"
SIL. 8" x 4"

Day-Nite (215) 455-2121

FERTIK'S ELECTRONICS

Components & Equipment

LEON FERTIK

5400 ELLA STREET
PHILADELPHIA, PA. 19120

RICHARD E. COMLY

ARROW

TOOL, DIE & MACHINE CO., INC.
2065 BENNETT RD. PHILA., PA 19116

(215) 876-1300
FAX 934-9237



(808) 268-0738

RICHARD CONNOR



RECON Communications

- COMMUNICATIONS TOWER MAINTENANCE
- ANTENNAS, FEEDLINES, TOWERS INSTALLED
- TOWER PAINTING, RE-LAMPING, RE-GUYING
- RF SYSTEM TROUBLESHOOTING
- LIGHTNING PROTECTION, GROUND SYSTEMS

Emergency Service

412 Carranza Road
Tabernacle, NJ 08068

(302) 328-7728
ORDER LINE 800-441-7008



Delaware Amateur Supply
"AMATEUR SALES AND SERVICE"

ROB WA3OLS
GAIL KA3ITN

71 MEADOW ROAD
NEW CASTLE, DELAWARE 19720

(215) 745-6173
(302) 886-7630
(215) 342-8832
(609) 266-3668



COMPU-SIMPLE, INC.
COMPUTER APPLICATIONS FOR SMALL BUSINESS

ELLIOTT T. WEISMAN
Consultant

P.O. BOX 7161
WILMINGTON, DELAWARE 19803

RUTLAND ARRAYS

For the finest VHF/UHF antennas
1703 WARREN ST.
NEW CUMBERLAND, PA 17070

Call or write for our new catalog!
(717) 774-5298 7-10 pm EST

STEVEN N. WHITE
Attorney at Law

WA3IAO

2217 PALOMINO DRIVE
WARRINGTON, PA 18976

TEL: (215) 343-6902
FAX: (215) 343-6903

Xcelite

Service Since 1956
417 DAVISVILLE ROAD
WILLOW GROVE, PA 19090
215-659-5900

"Right in the middle of a lot of good company!"
Electronic Equipment Distributor
"HAM" BUEGER, INC.

If we're judged by the company we keep, we should do pretty well!



Wilson Electronics Corp.
SPRAGUE
TELEX
AMPHENOL
CUSHCROTT
TAB BOOKS
TEN-TEC
TRW
NBC
VIBROPLEX
Beamcat
"W2AU" HAM-KEY
Larsen Antennas
ROHN
ASITAC
Miller
DRAKE
CDK
Saxon
ICOM
CHS
Weller
TPL
GILFER LMB
nte
Waldom
callbook
M.W.
communications specialists
MISCO
BITO
Vector
HUSTER
George
AMSCO
SWAN
COVER CRAFT
AMF SPECIAL INDUSTRIES
COMAR
W2AU
W2AUA
W2AUB
W2AUC
W2AUD
W2AUE
W2AUF
W2AUG
W2AUH
W2AUJ
W2AUK
W2AUL
W2AUM
W2AUN
W2AUO
W2AUP
W2AUQ
W2AUR
W2AUS
W2AUT
W2AUU
W2AUV
W2AUW
W2AUX
W2AUZ

Cheese Bits
412 Carranza Rd
Tabernacle, NJ
08088

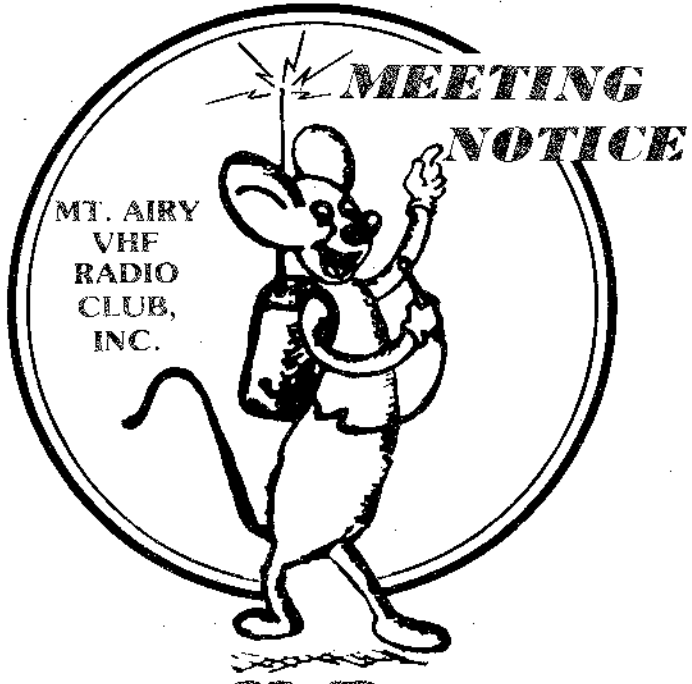
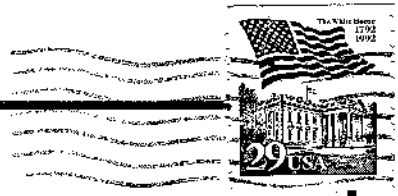

**MT. AIRY
VHF
RADIO
CLUB,
INC.**

DICK HUNTZINGER
W3FQD
130 FAIRHILL RD.
CHURCHVILLE, PA 18966

12/92

PACK RATS

FIRST CLASS